

Phase Noise Guide

Agilent Technologies PSA Series Spectrum Analyzers Option 226



**Manufacturing Part Number: E4440-90328
Supersedes: E4440-90233**

Printed in USA

May 2007

© Copyright 2000 - 2007 Agilent Technologies, Inc.

Notice

The information contained in this document is subject to change without notice.

Agilent Technologies makes no warranty of any kind with regard to this material, including but not limited to, the implied warranties of merchantability and fitness for a particular purpose. Agilent Technologies shall not be liable for errors contained herein or for incidental or consequential damages in connection with the furnishing, performance, or use of this material.

Where to Find the Latest Information

Documentation is updated periodically. For the latest information about Agilent PSA Spectrum Analyzers, including firmware upgrades, software upgrades, application information, and product information, please visit the following Internet URL:

<http://www.agilent.com/find/psa>

1. Getting Started

Introduction	14
Specifications	14
Installing Optional Measurement Personalities	15
Do You Have Enough Memory to Load All Your Personality Options?	15
How to Predict Your Memory Requirements	17
Loading an Optional Measurement Personality	19
Obtaining and Installing a License Key	19
Viewing a License Key	20
Using the Delete License Key on PSA	20
Ordering Optional Measurement Personalities	21
Starting the Phase Noise Personality	22

2. Using the Phase Noise Personality

Using the Phase Noise Personality	24
Phase Noise Measurements	25
Log Plot Measurements	25
Spot Frequency Measurements	26
Smoothing, Averaging and Filtering	26
Signal Tracking	27
Measurement Considerations	28
Slowly Drifting Signals	28
System Noise Floor	28
Cancellation and Log Plot Measurements	29
Background Information	29
Log Plot Cancellation	30
Creating a DANL Floor Reference Trace	31
Example Measurement -	
Using a DANL Reference for Cancellation	31
Creating a Signal Phase Noise Reference Trace	34
Example Measurement -	
Using a Phase Noise Measurement for Cancellation	34
Saving Traces	36
Restoring Traces	36

3. Menu Maps

What You Will Find in This Chapter	40
Menus	41
Amplitude Menu - Log Plot	41
Amplitude Menu - Spot Frequency	42
BW/Avg Menu	43
Det/Demod Menu - Log Plot and Spot Frequency	44
Display Menu - Log Plot	45
Display Menu - Monitor Spectrum	46
Display Menu - Spot Frequency	47
File Menu (1 of 6)	48
File Menu (2 of 6)	49
File Menu (3 of 6)	50

Contents

File Menu (4 of 6)	51
File Menu (5 of 6)	52
File Menu (6 of 6)	53
Frequency/Channel Menu	54
Input Output Menu	55
Marker Menu - Log Plot	56
Measure Menu	57
Meas Setup Menu - Log Plot	58
Meas Setup Menu - Monitor Spectrum	59
Meas Setup Menu - Spot Frequency	60
Mode Menu	61
Mode Setup Menu	62
Span (X Scale) Menu - Log Plot	63
Span (X Scale) Menu - Monitor Spectrum	64
Span (X Scale) Menu - Spot Frequency	65
Sweep Menu - Log Plot	66
Sweep Menu - Spot Frequency	67
Trigger Menu	68
Trace/View Menu - Log Plot	69
Trace/View Menu - Monitor Spectrum	70
Trace/View Menu - Spot Frequency	71

4. Front-Panel Key Reference

Key Descriptions and Locations	74
AMPLITUDE Y Scale	75
Monitor Spectrum Measurements	75
Log Plot Measurements	75
Spot Frequency Measurements	76
BW/Avg	77
Det/Demod	78
Display	79
FREQUENCY Channel	80
Input/Output	82
Marker	83
Monitor Spectrum Measurements	83
Spot Frequency Measurements	83
Log Plot Measurement	83
Meas Setup	85
MEASURE	89
MODE	90
Mode Setup	91
Preset	92
SPAN X Scale	93
Monitor Spectrum Measurements	93
Log Plot Measurements	93
Spot Frequency Measurements	93
Sweep Menu	94
Trace/View	95
Monitor Spectrum Measurements	95

Log Plot Measurements	95
Spot Frequency Measurements	96

5. Language Reference

CALCulate Subsystem	98
CALCulate:LPLot Subsystem	98
CALCulate:MARKers Subsystem	99
CONFIgure Subsystem	102
Configure the Selected Measurement	102
Configure Query	102
DISPlay Subsystem.	103
Set the Display Line	103
Control the Display Line	103
Set the Display Reference Level	103
Set the Display Amplitude Scale.	104
FETCH Subsystem	105
Fetch the Current Measurement Results	105
FORMat Subsystem	106
Measurement Results format	106
INITiate Subsystem.	107
Take New Data Acquisition for Selected Measurement	107
INSTRument Subsystem	108
Catalog Query	108
Select Application by Number	108
Select Application	109
MEASure Group of Commands	111
CONFIgure, FETCH, MEASure, READ Interactions	111
Phase Noise Log Plot Measurement	115
Monitor Spectrum	117
Phase Noise Spot Frequency Measurement	118
MMEMory Subsystem	119
Load a Log Plot Reference Trace from Disk	119
Store a Log Plot Reference Trace to Disk	120
READ Subsystem	121
Initiate and Read Measurement Data	121
SENSE Subsystem.	122
Display Average Noise Level—Measurement Method	122
Default Reset	122
Frequency Commands	123
Amplitude Commands.	126
Bandwidth Commands	127
Detector Commands	130
Phase Noise Log Plot Measurements	130
Monitor Band/Channel Measurement	137
RF Power Commands	140
Spot Frequency Measurements	141

6. Phase Noise Measurement Concepts

Contents

Introduction	148
What is Phase Noise?	149
Thermal Noise	151
Other Noise Contributions	152
AM Noise	153
Residual FM	154
Single-Sideband Noise	154
Phase Noise Measurements	157
Log Plot Measurements	157
Spot Frequency Measurements	157
Improving Phase Noise Measurements	158
Smoothing, Averaging and Filtering	158
Signal Tracking	158
Slowly Drifting Signals	158
System Noise Floor	159
Advanced Features - AM Rejection and Overdrive	159
Additional Information	160
7. If You Have A Problem	
Agilent Customer Assistance	162

List of Commands

:CALCulate:LPLot:DECade:TABLE[:STATe] OFF ON 0 1	98
:CALCulate:LPLot:DECade:TABLE[:STATe]?	98
:CALCulate:LPLot:MARKer:TABLE[:STATe] OFF ON 0 1	100
:CALCulate:LPLot:MARKer:TABLE[:STATe]?	100
:CALCulate:LPLot:MARKer[1] 2 3 4:MODE POSition DELTA RMSDegree RMSRadian RFM RMSJitter OFF	99
:CALCulate:LPLot:MARKer[1] 2 3 4:MODE?	99
:CALCulate:LPLot:MARKer[1] 2 3 4:TRACe <tracenum>	100
:CALCulate:LPLot:MARKer[1] 2 3 4:TRACe?	100
:CALCulate:LPLot:MARKer[1] 2 3 4:X <number>	100
:CALCulate:LPLot:MARKer[1] 2 3 4:X?	100
:CALCulate:LPLot:MARKer[1] 2 3 4:Y?	101
:CALCulate:LPLot:TRACe:COPI[A][B]	98
:CALCulate:LPLot:TRACe:SWAP[A][B]	99
:CALCulate:LPLot:TRACe[1] 2 3:MODE RAW SMOothed VIEW BLANK	98
:CALCulate:LPLot:TRACe[1] 2 3:MODE?	98
:CONFigure:<measurement>	102
:CONFigure:MONitor	117
:CONFigure?	102
:DISPlay:MONitor:WINDow:TRACe:Y:DLINe <ampl>	103
:DISPlay:MONitor:WINDow:TRACe:Y:DLINe:STATe OFF ON 0 1	103
:DISPlay:MONitor:WINDow:TRACe:Y:DLINe:STATe?	103
:DISPlay:MONitor:WINDow:TRACe:Y:DLINe?	103
:DISPlay:MONitor:WINDow:TRACe:Y:RLEVel	103
:DISPlay:MONitor:WINDow:TRACe:Y:RLEVel?	103
:DISPlay:MONitor:WINDow:TRACe:Y[:SCALE]:PDIVision	104
:DISPlay:MONitor:WINDow:TRACe:Y[:SCALE]:PDIVision?	104
:FETCh:<measurement>[n]?	105
:FETCh:LPLot[n]?	115
:FETCh:MONitor[n]	117
:FETCh:SFRequency[n]?	118

List of Commands

:FORMat:MEASure[:DATA] ASCii REAL32	106
:FORMat:MEASure[:DATA]?	106
:INITiate:<measurement>	107
:INSTrument:CATalog?	108
:INSTrument:NSElect <integer>	108
:INSTrument:NSElect?	108
:INSTrument[:SElect] SA PNOISE BASIC CDMA CDMA2K EDGE GSM NADC PDC WCDMA CDMA1XEV NFIGURE WLAN MRECEIVE TDSCDMA TDDEMOD EMC DEMODULATION	109
:INSTrument[:SElect]?	109
:MEASure:LPLot[n]?	115
:MEASure:MONitor[n]	117
:MEASure:SFRrequency[n]?	118
:MMEMory:LPLot:LOAD:TRACe <tracenum>,<filename>	119
:MMEMory:LPLot:LOAD:TRACe <tracenum>,<filename>	119
:MMEMory:LPLot:STORE:TRACe <tracenum>,<filename>	120
:MMEMory:LPLot:STORE:TRACe <tracenum>,<filename>	120
:READ:<measurement>[n]?	121
:READ:LPLot[n]?	115
:READ:MONitor[n]	117
:READ:SFRrequency[n]?	118
[:SENSe]:DANL:METhod ATTenuator REMoval	122
[:SENSe]:DANL:METhod?	122
[:SENSe]:DEFaults	122
[:SENSe]:FREQuency:CARRier <freq>	123
[:SENSe]:FREQuency:CARRier:SEARch	123
[:SENSe]:FREQuency:CARRier:SEARch:AUTO ON OFF 1 0	123
[:SENSe]:FREQuency:CARRier:SEARch:AUTO?	123
[:SENSe]:FREQuency:CARRier:SEARch:SPAN <freq>	124
[:SENSe]:FREQuency:CARRier:SEARch:SPAN?	124
[:SENSe]:FREQuency:CARRier:TRACk:DSpan <value>	124
[:SENSe]:FREQuency:CARRier:TRACk:DSpan?	124

List of Commands

[:SENSe]:FREQuency:CARRier:TRACk:INTerval <value>	125
[:SENSe]:FREQuency:CARRier:TRACk:INTerval?	125
[:SENSe]:FREQuency:CARRier:TRACk:METHod INTerval TOLerance BOTH	125
[:SENSe]:FREQuency:CARRier:TRACk:METHod?	125
[:SENSe]:FREQuency:CARRier:TRACk:TOLerance <value>	126
[:SENSe]:FREQuency:CARRier:TRACk:TOLerance?	126
[:SENSe]:FREQuency:CARRier:TRACk[:STATe] OFF ON 1 0	124
[:SENSe]:FREQuency:CARRier:TRACk[:STATe]?	124
[:SENSe]:FREQuency:CARRier?	123
[:SENSe]:LPLot:AVERAge[:STATe] ON OFF 1 0	131
[:SENSe]:LPLot:AVERAge:COUNT <integer>	130
[:SENSe]:LPLot:AVERAge:COUNT?	130
[:SENSe]:LPLot:AVERAge:TCONtrol?	131
[:SENSe]:LPLot:AVERAge[:STATe]?	131
[:SENSe]:LPLot:BANDwidth BWIDth:VIDeo:AUTO?	132
[:SENSe]:LPLot:BANDwidth BWIDth:VIDeo:RATio <numeric>	132
[:SENSe]:LPLot:BANDwidth BWIDth:VIDeo:RATio?	132
[:SENSe]:LPLot:BANDwidth BWIDth:VIDeo?	132
[:SENSe]:LPLot:BANDwidth BWIDth[:RESolution]:AUTO?	132
[:SENSe]:LPLot:BANDwidth BWIDth[:RESolution]?	131
[:SENSe]:LPLot:CANCellation:DELTA <dB>	132
[:SENSe]:LPLot:CANCellation:DELTA?	133
[:SENSe]:LPLot:CANCellation:TRACe <tracenum>	133
[:SENSe]:LPLot:CANCellation:TRACe?	133
[:SENSe]:LPLot:CANCellation[:STATe] OFF ON 0 1	133
[:SENSe]:LPLot:CANCellation[:STATe]?	133
[:SENSe]:LPLot:DETEctor[:FUNction]?	134
[:SENSe]:LPLot:DIAG:GRAPh:Y:REFerence <level>	134
[:SENSe]:LPLot:DIAG:GRAPh:Y:REFerence?	134
[:SENSe]:LPLot:FILTeriNg:NONE LITTLe MEDium MAXimum	134
[:SENSe]:LPLot:FREQuency:OFFSet:STARt <freq>	134

List of Commands

[:SENSe]:LPLot:FREQuency:OFFSet:START?	134
[:SENSe]:LPLot:FREQuency:OFFSet:STOP <freq>	135
[:SENSe]:LPLot:FREQuency:OFFSet:STOP?	135
[:SENSe]:LPLot:FREQuency:SPAN:BANDwidth BWIDth[:RESolution]:RATio <numeric>	135
[:SENSe]:LPLot:FREQuency:SPAN:BANDwidth BWIDth[:RESolution]:RATio:AUTO ON OFF 1 0	136
[:SENSe]:LPLot:FREQuency:SPAN:BANDwidth BWIDth[:RESolution]:RATio:AUTO?	136
[:SENSe]:LPLot:FREQuency:SPAN:BANDwidth BWIDth[:RESolution]:RATio?	135
[:SENSe]:LPLot:METHod DANL PN	136
[:SENSe]:LPLot:METHod?	136
[:SENSe]:LPLot:SMOoth <percentage>	136
[:SENSe]:LPLot:SMOoth?	136
[:SENSe]:MONitor:POWer[:RF]:RANGe:AUTO	126
[:SENSe]:MONitor:AVERAge:COUNt <integer>	137
[:SENSe]:MONitor:AVERAge:COUNt?	137
[:SENSe]:MONitor:AVERAge:TCONtrol EXPonential REPeat	138
[:SENSe]:MONitor:AVERAge:TCONtrol?	138
[:SENSe]:MONitor:AVERAge[:STATe] OFF ON 0 1	138
[:SENSe]:MONitor:AVERAge[:STATe]?	138
[:SENSe]:MONitor:BANDwidth BWIDth:VIDeo:AUTO?	128
[:SENSe]:MONitor:BANDwidth BWIDth:VIDeo:RATio <value>	129
[:SENSe]:MONitor:BANDwidth BWIDth:VIDeo:RATio?	129
[:SENSe]:MONitor:BANDwidth BWIDth:VIDeo?	128
[:SENSe]:MONitor:BANDwidth BWIDth[:RESolution]:AUTO?	128
[:SENSe]:MONitor:BANDwidth BWIDth[:RESolution]?	127
[:SENSe]:MONitor:DETEctor[:FUNction]	130
[:SENSe]:MONitor:DETEctor[:FUNction]?	130
[:SENSe]:MONitor:FREQuency:SPAN <freq>	138
[:SENSe]:MONitor:FREQuency:SPAN:BANDwidth BWIDth [:RESolution]:RATio <value>	129

List of Commands

[[:SENSe]:MONitor:FREQuency:SPAN:BANDwidth BWIDth [:RESolution]:RATio:AUTO ON OFF 1 0	129
[[:SENSe]:MONitor:FREQuency:SPAN:BANDwidth BWIDth [:RESolution]:RATio:AUTO?	129
[[:SENSe]:MONitor:FREQuency:SPAN:BANDwidth BWIDth [:RESolution]:RATio?	129
[[:SENSe]:MONitor:FREQuency:SPAN:FULL	139
[[:SENSe]:MONitor:FREQuency:SPAN:ZERO	139
[[:SENSe]:MONitor:FREQuency:SPAN?	138
[[:SENSe]:MONitor:POWer[:RF]:ATTenuation	126
[[:SENSe]:MONitor:POWer[:RF]:ATTenuation:AUTO	127
[[:SENSe]:MONitor:POWer[:RF]:ATTenuation:AUTO?	127
[[:SENSe]:MONitor:POWer[:RF]:ATTenuation?	126
[[:SENSe]:MONitor:SWEep:POINts?	139
[[:SENSe]:MONitor:SWEep:TIME <value>	140
[[:SENSe]:MONitor:SWEep:TIME:AUTO ON OFF 1 0	140
[[:SENSe]:MONitor:SWEep:TIME:AUTO?	140
[[:SENSe]:MONitor:SWEep:TIME?	140
[[:SENSe]:POWer[:RF]:MIXer:RANGe[:UPPer] <power>	140
[[:SENSe]:POWer[:RF]:MIXer:RANGe[:UPPer]?	140
[[:SENSe]:SFRequency:AVERage:COUNt <integer>	141
[[:SENSe]:SFRequency:AVERage:COUNt?	141
[[:SENSe]:SFRequency:AVERage:TCONtrol EXPonential REPeat	142
[[:SENSe]:SFRequency:AVERage:TCONtrol?	142
[[:SENSe]:SFRequency:AVERage[:STATe] ON OFF 1 0	141
[[:SENSe]:SFRequency:AVERage[:STATe]?	141
[[:SENSe]:SFRequency:BANDwidth BWIDth:VIDeo:AUTO?	143
[[:SENSe]:SFRequency:BANDwidth BWIDth:VIDeo:RATio <numeric>	143
[[:SENSe]:SFRequency:BANDwidth BWIDth:VIDeo:RATio?	143
[[:SENSe]:SFRequency:BANDwidth BWIDth:VIDeo?	142
[[:SENSe]:SFRequency:BANDwidth BWIDth[:RESolution]:AUTO?	142
[[:SENSe]:SFRequency:BANDwidth BWIDth[:RESolution]?	142

List of Commands

[:SENSe]:SFRequency:DETEctor[:FUNCTion]?	143
[:SENSe]:SFRequency:METHod DANL PN	143
[:SENSe]:SFRequency:METHod?	143
[:SENSe]:SFRequency:PNOFfrequency <freq>	144
[:SENSe]:SFRequency:PNOFfrequency:AUTO ON OFF 1 0	144
[:SENSe]:SFRequency:PNOFfrequency:AUTO?	144
[:SENSe]:SFRequency:PNOFfrequency?	144
[:SENSe]:SFRequency:SOFFset <value>	145
[:SENSe]:SFRequency:SOFFset:BANDwidth BWIDth[:RESolution] :RATio <value>	145
[:SENSe]:SFRequency:SOFFset:BANDwidth BWIDth[:RESolution] :RATio?	145
[:SENSe]:SFRequency:SOFFset?	145
[:SENSe]:SFRequency:SWEep:TIME <value>	145
[:SENSe]:SFRequency:SWEep:TIME:AUTO ON OFF 1 0	146
[:SENSe]:SFRequency:SWEep:TIME:AUTO?	146
[:SENSe]:SFRequency:SWEep:TIME?	145

1 Getting Started

Introduction

The Option 226 Phase Noise Measurement Personality is a downloadable program (DLP) that is used with the PSA Series spectrum analyzers to make single sideband phase noise measurements. You need the following equipment to use the utility:

Table 1-1 Equipment/Upgrades Required for Using Option 226

Analyzer	Firmware
E4440A	A.10.00 or later
E4443A	A.10.00 or later
E4445A	A.10.00 or later

The following procedures describe how to install the file and access the personality.

Specifications

Performance specifications can be found in the “PSA Series Specifications Guide”.

Installing Optional Measurement Personalities

When you install a measurement personality, you need to follow a three step process:

1. Determine whether your memory capacity is sufficient to contain all the options you want to load. If not, decide which options you want to install now, and consider upgrading your memory. Details follow in “Do You Have Enough Memory to Load All Your Personality Options?” on page 15.
2. Install the measurement personality firmware into the instrument memory. Details follow in “Loading an Optional Measurement Personality” on page 19.
3. Enter a license key that activates the measurement personality. Details follow in “Obtaining and Installing a License Key” on page 19.

Adding measurement personalities requires the purchase of an upgrade kit for the desired option. The upgrade kit contains the measurement personality firmware and an entitlement certificate that is used to generate a license key from the internet website. A separate license key is required for each option on a specific instrument serial number and host ID.

For the latest information on Agilent Spectrum Analyzer options and upgrade kits, visit the following web location:

http://www.agilent.com/find/sa_upgrades

Do You Have Enough Memory to Load All Your Personality Options?

If you do not have memory limitations then you can skip ahead to the next section “Loading an Optional Measurement Personality” on page 19. If after installing your options you get error messages relating to memory issues, you can return to this section to learn more about how to optimize your configuration.

If you have 64 MBytes of memory installed in your instrument, you should have enough memory to install at least four optional personalities, with plenty of memory for data and states.

The optional measurement personalities require different amounts of memory. So the number of personalities that you can load varies. This is also impacted by how much data you need to save. If you are having memory errors you must swap the applications in or out of memory as needed. If you only have 48 MBytes of memory, you can upgrade your

hardware to 64 MBytes.

Additional memory can be added to any PSA Series analyzer by installing Option 115. With this option installed, you can install all currently available measurement personalities in your analyzer and still have memory space to store more state and trace files than would otherwise be possible.

To see the size of your installed memory for PSA Series Spectrum Analyzers:

1. Ensure that the spectrum analyzer is in spectrum analyzer mode because this can affect the screen size.
2. Press **System, More, Show Hdw.**
3. Read Flash Memory size in the table. If Option 115 is installed (PSA only), the table will also show Compact Flash Type and Compact Flash Size.

PSA Flash Memory Size	Available Memory Without Option B7J and Option 122 or 140	Available Memory With Option B7J and Option 122 or 140
64 Mbytes	32.5 MBytes	30.0 MBytes
48 Mbytes	16.9 MBytes	14.3 MBytes

PSA Compact Flash Memory Size	Available Additional Memory for Measurement Personalities
512 Mbytes (Opt. 115)	512 MBytes

If you have 48 MBytes of memory, and you want to install more than 3 optional personalities, you may need to manage your memory resources. The following section, “How to Predict Your Memory Requirements” on page 17, will help you decide how to configure your installed options to provide optimal operation.

How to Predict Your Memory Requirements

If you plan to install many optional personalities, you should review your memory requirements, so you can determine whether you have enough memory (unless you have a PSA Series with Option 115). There is an Agilent “Memory Calculator” available online that can help you do this, or you can make a calculated approximation using the information that follows. You will need to know your instrument’s installed memory size as determined in the previous section and then select your desired applications.

NOTE

If you have a PSA Series analyzer with Option 115, there is adequate memory to install all of the available optional personalities in your instrument.

To calculate the available memory on your PSA, see:
<http://sa.tm.agilent.com/PSA/memory/>

Select the “Memory Calculator” link. You can try any combination of available personalities to see if your desired configuration is compatible with your installed memory.

NOTE

After loading all your optional measurement personalities, you should have a reserve of ~2 MBytes memory to facilitate mode switching. Less available memory will increase mode switching time. For example, if you employ excessive free memory by saving files of states and/or data, your mode switching time can increase to more than a minute.

You can manually estimate your total memory requirements by adding up the memory allocations described in the following steps. Compare the desired total with the available memory that you identified in the previous section.

1. Program memory - Select option requirements from the table “Measurement Personality Options and Memory Required” on page 18.
2. Shared libraries require 7.72 MBytes.
3. Recommended mode swap space is 2 MBytes.
4. Screens - .gif files need 20-25 kBytes each
5. State memory - State file sizes range from 21 kB for SA mode to 40 kB for W-CDMA. The state of every mode accessed since power-on will be saved in the state file. File sizes can exceed 150 kB each when several modes are accessed, for each state file saved.

TIP

State memory retains settings for all states accessed before the **Save State** command. To reduce this usage to a minimum, reduce the modes accessed before the **Save State** is executed. You can set the PSA to boot into a selected mode by accessing the desired mode, then pressing the **System, Power On/Preset, Power On** keys and toggle the setting to **Last**.

Measurement Personality Options and Memory Required

Personality Options for PSA Series Spectrum Analyzers ^a	Option	File Size (PSA Rev: A.10)
cdmaOne measurement personality	BAC	1.91 Mbytes
NADC and PDC measurement personalities (not available separately)	BAE	2.43 Mbytes
W-CDMA or W-CDMA, HSDPA, HSUPA measurement personality	BAF, 210	5.38 Mbytes ^b
cdma2000 or cdma2000 w/ 1xEV-DV measurement personality	B78, 214	4.00 Mbytes ^b
1xEV-DO measurement personality	204	5.61 Mbytes ^b
GSM (with EDGE) measurement personality	202	3.56 Mbytes ^b
Shared measurement library ^b	n/a	7.72 Mbytes
Phase Noise measurement personality	226	2.82 Mbytes ^c
Noise Figure measurement personality	219	4.68 Mbytes ^c
Basic measurement personality with digital demod hardware	B7J	Cannot be deleted (2.64 Mbytes)
Programming Code Compatibility Suite ^d (8560 Series, 8590 Series, and 8566/8568)	266	1.18 Mbytes ^c
TD-SCDMA Power measurement personality	211	5.47 Mbytes ^b
TD-SCDMA Modulation Analysis or TD-SCDMA Modulation Analysis w/ HSDPA/8PSK measurement personality	212, 213	1.82 Mbytes
Flexible Digital Modulation Analysis	241	2.11 Mbytes ^b
WLAN measurement personality	217	3.24 Mbytes ^b
External Source Control	215	0.72 Mbytes ^c
Measuring Receiver Personality (available with Option 23A - Trigger support for AM/FM/PM and Option 23B - CCITT filter)	233	2.91 Mbytes ^b
EMC Analyzer	239	4.06 Mbytes ^b

- a. Available as of the print date of this guide.
- b. Many PSA Series personality options use a 7.72 Mbyte shared measurement library. If you are loading multiple personalities that use this library, you only need to add this memory allocation once.
- c. Shared measurement library allocation not required.
- d. This is a no charge option that does not require a license key.

Memory Upgrade Kits

The PSA 64 MByte Memory Upgrade kit part number is E4440AU-ANE. The PSA Compact Flash Upgrade kit part number is E4440AU-115.

For more information about memory upgrade kits contact your local sales office, service office, or see:

http://www.agilent.com/find/sa_upgrades

Loading an Optional Measurement Personality

You must use a PC to load the desired personality option into the instrument memory. Loading can be done from a firmware CD-ROM or by downloading the update program from the internet. An automatic loading program comes with the files and runs from your PC.

You can check the Agilent internet website for the latest PSA firmware versions available for downloading:

http://www.agilent.com/find/psa_firmware

NOTE

When you add a new option, or update an existing option, you will get the updated versions of all your current options as they are all reloaded simultaneously. This process may also require you to update the instrument core firmware so that it is compatible with the new option.

Depending on your installed hardware memory, you may not be able to fit all of the available measurement personalities in instrument memory at the same time. You may need to delete an existing option file from memory and load the one you want. Use the automatic update program that is provided with the files. Refer to the table showing “Measurement Personality Options and Memory Required” on page 18. The approximate memory requirements for the options are listed in this table. These numbers are worst case examples. Some options share components and libraries, therefore the total memory usage of multiple options may not be exactly equal to the combined total.

Obtaining and Installing a License Key

If you purchase an optional personality that requires installation, you will receive an “Entitlement Certificate” which may be redeemed for a license key specific to one instrument. Follow the instructions that accompany the certificate to obtain your license key.

To install a license key for the selected personality option, use the following procedure:

NOTE

You can also use this procedure to reinstall a license key that has been deleted during an uninstall process, or lost due to a memory failure.

1. Press **System, More, More, Licensing, Option** to access the alpha editor. Use this alpha editor to enter letters (upper-case), and the front-panel numeric keys to enter numbers for the option designation. You will validate your option entry in the active function area of the display. Then, press the **Enter** key.
2. Press **License Key** to enter the letters and digits of your license key. You will validate your license key entry in the active function area of the display. Then, press the **Enter** key.
3. Press the **Activate License** key.

Viewing a License Key

Measurement personalities purchased with your instrument have been installed and activated at the factory before shipment. The instrument requires a **License Key** unique to every measurement personality purchased. The license key is a hexadecimal number specific to your measurement personality, instrument serial number and host ID. It enables you to install, or reactivate that particular personality.

Use the following procedure to display the license key unique to your personality option that is already installed in your PSA:

Press **System, More, More, Licensing, Show License**. The **System, Personality** key displays the personalities loaded, version information, and whether the personality is licensed.

NOTE

*You will want to keep a copy of your license key in a secure location. Press **System, More**, then **Licensing, Show License**, and print out a copy of the display that shows the license numbers. If you should lose your license key, call your nearest Agilent Technologies service or sales office for assistance.*

Using the Delete License Key on PSA

This key will make the option unavailable for use, but will not delete it from memory. Write down the 12-digit license key for the option before you delete it. If you want to use that measurement personality later, you will need the license key to reactivate the personality firmware.

NOTE

Using the **Delete License** key does not remove the personality from the instrument memory, and does not free memory to be available to install another option. If you need to free memory to install another option, refer to the instructions for loading firmware updates located at the URL : <http://www.agilent.com/find/psa/>

1. Press **System, More, More, Licensing, Option**. Pressing the **Option** key will activate the alpha editor menu. Use the alpha editor to enter the letters (upper-case) and the front-panel numeric keyboard to enter the digits (if required) for the option, then press the **Enter** key. As you

enter the option, you will see your entry in the active function area of the display.

2. Press **Delete License** to remove the license key from memory.

Ordering Optional Measurement Personalities

When you order a personality option, you will receive an entitlement certificate. Then you will need to go to the Web site to redeem your entitlement certificate for a license key. You will need to provide your instrument serial number and host ID, and the entitlement certificate number.

Required Information:	Front Panel Key Path:
Model #: (Ex. E4440A)	
Host ID: _____	System, Show System
Instrument Serial Number: _____	System, Show System

Starting the Phase Noise Personality

The phase noise personality can be started easily once the program has been licensed and installed.

Press **MODE**, then **Phase Noise** to start the utility.

Using the Phase Noise Personality

This chapter includes the following:

[“Phase Noise Measurements” on page 2-25](#)

- Log Plot Measurements
- Spot Frequency Measurements
- Smoothing, Averaging, and Filtering
- Signal Tracking

[“Measurement Considerations” on page 2-28](#)

- Slowly Drifting Signals
- System Noise Floor
- Display Accuracy at 10 dB Per Division

[“Cancellation and Log Plot Measurements” on page 2-29](#)

- Creating a DANL Floor Reference Trace
- Using a DANL Reference for Cancellation - Example Measurement
- Creating a Signal Phase Noise Reference Trace
- Using a Phase Noise Measurement for Cancellation - Example Measurement
- Saving Traces
- Restoring Traces

Phase Noise Measurements

Log Plot Measurements

The log plot measurement approximates a logarithmic frequency sweep with a set of linear sweeps that are pieced together. This gives a display of dBc/Hz versus logarithmic frequency offset for the single sideband measurement. Trace 1, which is the yellow trace, displays the point-by-point data as measured. Trace 2, the cyan blue trace, displays a smoothed version of trace 1. The amount of smoothing is determined by the current setting of the smoothing parameter. With the default settings, marker 1 is set to a frequency offset of 10 kHz, and the phase noise at that frequency is displayed numerically.

NOTE

The trace numbers, trace data and marker data referred to (above) apply if you are using the factory default settings, but these can be changed.

If the analyzer is set up to perform single sweeps, the **Measure Log Plot** softkey or the **Restart** key allow a measurement to be repeated with a single key press. This is useful for seeing effects of circuit changes where the carrier and offset frequencies of interest do not change. The analyzer can also be set up to perform continuous sweeps. In this case a new measurement will be started as soon as the previous one has completed. One way of setting continuous sweeps is to press the **Sweep** front-panel key followed by the **Sweep (Cont)** softkey. The other way is to press **Meas Control** and **Measure (Cont)**.

Up to four markers can be used to display various parameters of the measurement, although the default display only shows data for one marker. Setting **Marker Table** to **On** allows you to view the data from all of your markers at once.

Phase noise measurement results can be integrated over a selected frequency range to get the total RMS (root mean squared) noise in a given bandwidth. The frequency limits used for integration may be selected by pressing **Marker** then **RMS Noise**. Use the RPG knob or front-panel keys to select the starting point of your frequency range, and then select whether to display the result in radians or in degrees, or in seconds if **RMS Jitter** is selected. Now you can use the RPG knob or front-panel keys to select the end point of your frequency range. The results are displayed in radians, degrees or seconds, depending on your previous selection.

RMS Residual FM over a specified range can also be displayed using markers. Using a **Normal** marker, use the RPG knob or front-panel keys to position the marker at the start of your frequency range. Then press **Residual FM**, and use the RPG knob (or the front-panel keys) to position

the second marker at the end point of your frequency range. The display will show your frequency range and the measured RMS residual FM over this range. RMS phase noise measurements are based on the log plot data which is a single-sideband measurement. The RMS phase noise results are mathematically corrected to properly represent the true RMS phase deviations.

Spot Frequency Measurements

A spot frequency measurement is a single sideband measurement of the phase error at a specified offset frequency from the main carrier signal. The average value of the trace points displayed on the screen is indicated by a magenta pink line. The analyzer is normally set up to display a continuous sweep, although a single measurement can be performed by setting **Sweep** to **Single**.

The analyzer can be set up to track a drifting signal by pressing **FREQUENCY/Channel, Signal Track, On**. When signal tracking is on, a trace showing the change in frequency versus time is shown next to the spot frequency trace.

Smoothing, Averaging and Filtering

Repeatability of the measurement can be improved in several different ways. Smoothing is used with log plot measurements while trace averaging is used with spot frequency measurements. Video filtering can be used with both types of measurements.

The smoothing process averages a number of adjacent trace points from the raw trace, typically Trace 1, and displays the smoothed result in the second trace, typically Trace 2, for a log plot measurement. Smoothing is faster than averaging or filtering, but less accurate than either. Loss of accuracy is particularly noticeable when a trace has sudden changes in amplitude, for example when a carrier has a large discrete signal such as a spurious sideband. To smooth a trace, choose the **Smoothing** softkey in **Meas Setup**, and then adjust it between 0.00% and 16.0% using either the front-panel keys or the RPG knob. While inside the log plot measurement, each level of smoothing can be tried without having to make a new measurement.

The averaging process measures each frequency point multiple times, and then calculates and plots the average value.

Video filtering can be applied to the active trace when making measurements. Additional video filtering can increase the accuracy and repeatability of the measurement, but it will also make the measurement process slower. Filtering changes the ratio of the video bandwidth to the resolution bandwidth. Filtering is slower than smoothing or averaging, but is more accurate than either.

Signal Tracking

Signal tracking can be used in all measurements to track a slowly drifting signal. When it is enabled (**On**), the measurement will follow a slowly drifting signal by periodically reacquiring the carrier signal.

How often the analyzer will retune to the drifting signal depends on the measurement being performed, and on analyzer settings such as tracking mode, drift span, and tolerance. Log Plot and Monitor Spectrum do not have tolerance or drift span settings.

If the signal is not tracked correctly (such as might happen with a rapidly drifting signal), the analyzer may not be completely compensating for the drift, causing the measured phase noise to appear either higher or lower than it actually is.

Measurement Considerations

Slowly Drifting Signals

Spot frequency and log plot measurements can be made on slowly drifting signals by making use of the signal tracking function, although the measured value will be slightly inaccurate. The maximum drift rate that can be tracked will depend on analyzer settings such as **Search Span** and the tracking **Mode**, although it is unlikely that you will approach these limits in practice.

System Noise Floor

The system noise floor can have a significant effect on low phase noise measurements such as those that will typically be found at large frequency offsets. The system noise floor can be measured using one of two methods. For greater accuracy, use the Removal method of measurement, and for greater convenience, use the Attenuation method. See [Cancellation and Log Plot Measurements on page 29](#) for more details.

Cancellation and Log Plot Measurements

Many phase noise measurements do not benefit from cancellation. If the phase noise of your DUT is more than 10 dB higher than the analyzer noise, then cancellation has almost no effect on the calculated measurement data. The effectiveness of using the cancellation function also has a lower limit. When the phase noise of your DUT gets very close to the analyzer noise (within about 0.1 dB), the logarithmic nature of the calculation results in large, invalid cancellation values. The following table shows error cancellation values that will be applied to the measurement results for various DUT to analyzer phase noise ratios. Setting the threshold value limits the correction that will be applied.

Phase Noise of DUT relative to Phase Noise of Analyzer	Measurement Error Before Cancellation ^a	Threshold Δ Required for Maximum Cancellation
20 dB	0.043 dB	20.0 dB
10 dB	0.41 dB	10.41 dB
0 dB	3.01 dB	3.01 dB
-5.87 dB	6.87 dB	1.0 dB
-10 dB	10.41 dB	0.41 dB
-16.33 dB	16.43 dB	0.1 dB
-20 dB	20.04 dB	0.04 dB
-26.83 dB	26.84 dB	0.01 dB

a. Only considers error due to additive affects of analyzer noise and DUT noise.

Background Information

When you make a phase noise measurement on a given signal, the measurement result that you get is actually a combination of three different noise sources. The first source is the phase noise of the signal that you are measuring. If this noise is very small, it can be distorted or even hidden by the two other noise sources which are generated by the analyzer itself.

The first internal noise source is the phase noise generated by the analyzer as a side-effect of measuring an input signal. The second source is the Displayed Average Noise Level (DANL) of the analyzer. The DANL is the internally generated noise of the analyzer regardless

of whether or not an input signal is present, so the DANL is derived from the noise figure of the analyzer. The DANL floor is broadly flat across the spectrum and represents the absolute noise level below which measurements cannot be made because the signal gets lost in the analyzer noise.

If you make a measurement without any input signal, that measurement represents the absolute noise floor (DANL) of the analyzer. If you reference this absolute noise floor to the carrier amplitude, the DANL floor becomes a relative limit below which phase noise sidebands cannot be measured.

At far offset frequencies, the analyzer's phase noise is often below the analyzer's noise floor (DANL). The DANL floor of an analyzer thus limits the range over which an analyzer can measure phase noise. By making a log plot measurement of the analyzer's DANL noise floor, you are able to characterize the DANL limitation on phase noise measurements.

Log Plot Cancellation

The Log Plot measurement accuracy on low phase noise DUTs can be improved by using the cancellation feature to remove the affects of the analyzer's internal noise. This is done by comparing a stored reference measurement with the DUT's measured phase noise.

The stored reference measurement can be generated two ways.

- If you have a signal source that has much better phase noise than the analyzer's phase noise, then you can measure that source and know that the resulting trace represents the analyzer's internal phase noise when an input signal is present.
- If you do not have a good low-phase noise source, you can make a reference measurement with no input signal. This gives you a measurement of the analyzer's noise floor (DANL).

A reference trace from a good source that is relatively free of phase noise will let you compensate for both the phase noise and the DANL of the analyzer. A reference trace that is derived from the DANL only compensates for the DANL portion of the noise, but this may be adequate for measurement conditions where the analyzer DANL is the limiting factor (typically for offsets >1 to 10 MHz.)

This reference trace can be saved to the analyzer's own internal file system (the C: drive) or to a floppy disk. It can then be automatically subtracted from any subsequent log plot measurement to give you a more accurate result.

General Process

- Step 1.** Set up the analyzer as needed to measure the test signal's phase noise.

(For example, use the same frequency range as needed for your intended DUT measurement.)

- Step 2.** Create and save a reference trace in Trace 3. Create either a DANL reference or a signal phase noise reference. (See “[Creating a DANL Floor Reference Trace](#)” on page 31 or “[Creating a Signal Phase Noise Reference Trace](#)” on page 34.)
- Step 3.** Set up the analyzer so it is making a log plot measurement of the DUT’s phase noise and turn on the cancellation using the saved reference trace data.

Creating a DANL Floor Reference Trace

The reference trace must cover the same frequency range as your intended measurement.

- Step 1.** With the carrier signal connected, set up the analyzer to measure the phase noise over the desired frequency range.
- Step 2.** Press **Measure, Log Plot**.
- Step 3.** Set up the DANL floor measurement. Press **Meas Setup, Meas Type, DANL Floor**.
- Step 4.** Press **Input/Output** and **DANL Method**, to select either the **Atten** (Attenuation) or the **Removal** method for making the DANL measurement. (The **Removal** method will prompt you for additional steps.)
- Step 5.** Press **Restart**. You now have a reference trace available that you can either use immediately or save for later use. See the information about saving and restoring traces later in this section.

Example Measurement - Using a DANL Reference for Cancellation

Measuring a DANL Reference Trace

- Step 1.** With the test signal connected, set the analyzer to its startup condition by pressing **Preset**.
- Step 2.** Turn filtering on and set it to the maximum level. Press **Meas Setup, Filtering** and **Maximum**.
- Step 3.** Turn averaging on and set it to an appropriate level. Press **Meas Setup, Avg Number** (setting to **On** or **Off**), and enter an appropriate number if setting **Averaging On**.
- Step 4.** Select the frequency range that you want to use for your reference trace. Press **X Scale** and **Start Offset** to specify the start of the frequency

range, and **X Scale**, **Stop Offset** to specify the end of the frequency range. The range must be the same range that you will be measuring on your test signal.

- Step 5.** Set up and make the DANL floor measurement. Press **Meas Setup**, **Meas Type**, **DANL Floor** and **Restart**.
- Step 6.** Select which of the two possible methods of DANL floor measurement is to be made. Press **Input/Output**, and then press **DANL Method** to select either the **Atten** (Attenuation) or the **Removal** method.
- Step 7.** Press **Restart**. If you selected the signal removal method of DANL measurement, you will be asked to disconnect the input signal from the analyzer and to replace it with a 50Ω termination.

If you selected the attenuation method of measurement, the analyzer will effectively remove the input signal by automatically setting the attenuation to its maximum level of 70 dB. Whichever method is used, the analyzer will go through the measurement as if a signal was still present. The displayed average noise is measured and treated as phase noise, and normalized to the carrier amplitude. The DANL phase noise is then displayed as the phase noise trace.

- Step 8.** Once the measurement has completed, store the trace data in Trace number 3 by pressing **Trace/View**, **More 1 of 2**, **Operations** and **2 -> 3**. You now have a reference trace stored in Trace 3.

Applying Cancellation to a Log Plot Measurement

NOTE For a reference trace to be valid, it must be displayed in View mode, and must cover the same frequency range as your intended measurement.

- Step 1.** Go to the Cancellation menu under the Meas Setup menu. To do this, press **Meas Setup**, **More 1 of 2** and **Cancellation**.
- Step 2.** Select the trace that you wish to use as the reference trace (Trace 3). Press **Ref Trace** until the desired trace number is underlined. Trace number 1 is yellow, Trace number 2 is cyan blue and Trace number 3 is magenta pink.
- Step 3.** Set the threshold, if required, although you will not normally need to change this value. The noise cancellation measurement compares your current measurement with the reference trace on a point by point basis. At each point, the current measurement must exceed the reference trace by at least the threshold level. If the difference between the source trace and the reference trace is less than the threshold level, then the source trace is assumed to be exactly the threshold level above the reference level. To set the threshold level, press **Meas Setup**, **More 1 of 2**,

Cancellation and **Threshold**, and then set your threshold level in dB.

Step 4. Turn the cancellation **On** by pressing **Meas Setup, More 1 of 2, Cancellation** and **Cancellation** again. Any trace that is displaying smoothed data will change immediately to reflect the noise cancellation.

Table 2-1 Parameters of Interest When Performing a DANL Measurement

Parameter	Front Panel Access	Description
DANL Method	Input/Output, DANL Method	Determines which of the two possible methods is used to measure the DANL floor.
Max Mixer Level	Input/Output, Advanced, Max Mixer Level	Determines the amount of input attenuation to use, depending on the measured carrier amplitude and the particular offset being measured.
Blanking the raw data trace	(When using the default settings) Trace/View, Trace 1, Blank	The trace of the raw data (normally the yellow trace) can sometimes get in the way when you are working with smoothed traces. The raw data trace can be blanked out to leave just the smoothed traces on the display.
Trace Zooming	X Scale or Y Scale	Ensure that the measurement is in single sweep, and then use the RPG knob, the step keys or the numeric keypad to zoom in on a particular frequency range. As long as you are in Single Sweep mode, you do not need to make another measurement.
Decade Table	Meas Setup, More 1 of 2, Decade Table	This displays a table of offset frequencies versus amplitude. It provides an easy way of comparing spot amplitudes on different traces.

Creating a Signal Phase Noise Reference Trace

The reference trace must cover the same frequency range as your intended measurement.

- Step 1.** Set up the analyzer to measure the test signal phase noise over the desired frequency range. Press **Measure, Log Plot**.
- Step 2.** Connect a low phase noise signal source to the input of your analyzer and set it to the desired output frequency.
- Step 3.** Measure the phase noise of your reference signal. Press **Meas Setup, Meas Type, Phase Noise** and **Restart**. This measures and displays the phase noise of your test signal.
- Step 4.** You now have a reference trace available that you can either use immediately or save for later use. See the information about saving and restoring traces later in this section.

Example Measurement - Using a Phase Noise Measurement for Cancellation

Measuring a Signal Phase Noise Reference Trace

- Step 1.** Set the analyzer to its startup condition by pressing **Preset**.
- Step 2.** Turn filtering on and set it to the maximum level. Press **Meas Setup, Filtering** and **Maximum**.
- Step 3.** Turn averaging on and set it to an appropriate level. Press **Meas Setup, Avg Number** (setting to **On** or **Off**), and enter an appropriate number if setting **Averaging On**.
- Step 4.** Select the frequency range that you want to use for your reference trace. Press **X Scale** and **Start Offset** to specify the start of the frequency range, and **X Scale, Stop Offset** to specify the end of the frequency range. The range must be the same range that you will be measuring on your test signal.
- Step 5.** Connect a low phase noise signal source to the input of your analyzer and set it to the desired output frequency.
- Step 6.** Measure the phase noise of your reference signal. Press **Meas Setup, Meas Type, Phase Noise** and **Restart**. This measures and displays the phase noise of your signal. If you are using the analyzer's default settings, the raw data is displayed by the yellow trace, and the smoothed data is displayed by the cyan blue trace.
- Step 7.** Copy the smoothed trace data in Trace 2 (cyan blue) to Trace 3 (magenta pink) for later reference. Press **Trace/View, More 1 of 2**,

Operations and 2 -> 3 to copy the trace data. You now have a reference trace stored in Trace number 3.

Applying Cancellation to a Log Plot Measurement

NOTE For a reference trace to be valid, it must be displayed in View mode, and must cover the same frequency range as your intended measurement.

- Step 1.** Go to the Cancellation menu under the Meas Setup menu. To do this, press **Meas Setup, More 1 of 2** and **Cancellation**.
- Step 2.** Select the trace that you wish to use as the reference trace (Trace 3). Press **Ref Trace** until the desired trace number is underlined. Trace number 1 is yellow, Trace number 2 is cyan blue and Trace number 3 is magenta pink.
- Step 3.** Set the threshold if required, although you will not normally need to change this value. The noise cancellation measurement compares your current measurement with the reference trace on a point by point basis. At each point, the current measurement must exceed the reference trace by at least the threshold level. If the difference between the source trace and the reference trace is less than the threshold level, then the source trace is assumed to be exactly the threshold level above the reference level. To set the threshold level, press **Meas Setup, More 1 of 2, Cancellation** and **Threshold**, and then set your threshold level in dB.
- Step 4.** Turn the cancellation **On** by pressing **Meas Setup, More 1 of 2, Cancellation** and **Cancellation** again. Any trace that is displaying smoothed data will change immediately to reflect the noise cancellation.

Saving Traces

All traces, including the reference traces used for the noise cancellation measurement, can be saved to a floppy disk or to the analyzer's own internal file system (C:). All traces are saved in binary format, and their format is independent of the analyzer on which they were saved.

NOTE Traces cannot be saved in older versions of Option 226 Phase Noise Mode (firmware release A.07.xx or earlier).

- Step 1.** Select the trace you would like to save by pressing **Trace/View** and then **Trace**. Press **Trace** until the trace you wish to save is underlined.
- Step 2.** Go to the **Load/Save** menu which is under the **Trace/View** menu, and select the drive on which you would like to save the trace. Press **Trace/View, More 1 of 2, Load/Save** and **Drive**.
- Step 3.** Enter your filename. Press **Trace/View, More 1 of 2, Load/Save** and **Filename**, and then use the alphabetic keys to enter your filename. The file extension .LPT will automatically be added to the filename that you enter.
- Step 4.** Save the trace by pressing **Trace/View, More 1 of 2, Load/Save** and **Save Trace**.

NOTE Traces saved using this process in a Log Plot measurement are different than the "normal" analyzer traces. Traces saved from any other measurement (including measurements in Spectrum Analysis Mode) are not compatible with those saved under Log Plot measurements.

Restoring Traces

All traces, including the reference traces used for the noise cancellation measurement, can be loaded from a floppy disk or from the analyzer's own internal file system (C:). All traces are saved in binary format, and their format is independent of the analyzer on which they were saved.

NOTE Traces saved in Phase Noise Mode (Option 226) with older firmware releases may not be transportable to the newer releases.

- Step 1.** Select the trace you would like to replace by pressing **Trace/View** and then **Trace**. Press **Trace** until the trace you wish to replace is underlined.
- Step 2.** Go to the **Load/Save** menu which is under the **Trace/View** menu, and select the drive from which you would like to load the trace. Press **Trace/View, More 1 of 2, Load/Save**, and **Drive**.
- Step 3.** Enter your filename. Press **Trace/View, More 1 of 2, Load/Save** and **Filename**, and then use the alphabetic keys to enter your filename. The file extension .LPT will automatically be added to the filename that you

enter.

Step 4. Load the trace by pressing **Trace/View, More 1 of 2, Load/Save** and **Load Trace**. The trace is automatically set to View mode so it does not get overwritten.

NOTE

This method of saving and loading traces in a Log Plot measurement is different from the normal method of saving traces. Traces saved from any other measurement (including measurements in Spectrum Analysis Mode) are incompatible with those saved under Log Plot measurements.

3 Menu Maps

This chapter provides a visual representation of the front-panel keys and their associated menu keys. Refer to [Chapter 4](#), “[Front-Panel Key Reference](#),” on [page 73](#) for key function descriptions.

What You Will Find in This Chapter

This chapter provides menu maps for the front-panel keys having associated menus. The key menus appear in alphabetical order as follows:

AMPLITUDE Y Scale—Log Plot	Page 41
AMPLITUDE Y Scale—Spot Frequency	Page 42
BW/ Avg	Page 43
Det/Demod	Page 44
Display—Log Plot	Page 45
Display—Monitor Spectrum	Page 46
Display—Spot Frequency	Page 47
File	Page 48
FREQUENCY Channel	Page 54
Input Output	Page 55
Marker	Page 56
MEASURE	Page 57
Measurement Setup—Log Plot	Page 58
Measurement Setup—Monitor Spectrum	Page 59
Measurement Setup—Spot Frequency	Page 60
MODE	Page 61
Mode Setup	Page 62
SPAN X Scale—Log Plot	Page 63
SPAN X Scale—Monitor Spectrum	Page 64
SPAN X Scale—Spot Frequency	Page 65
Sweep—Log Plot	Page 66
Sweep—Spot Frequency	Page 67
Trig	Page 68
Trace/View—Log Plot	Page 69
Trace/View—Monitor Spectrum	Page 70
Trace/View—Spot Frequency	Page 71

Menus

Amplitude Menu - Log Plot

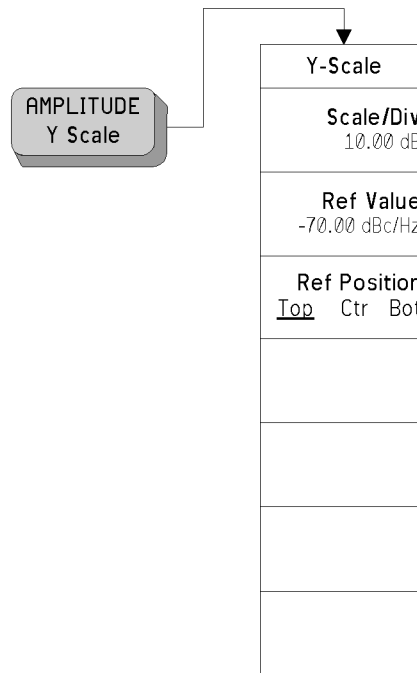

Amplitude Menu - Spot Frequency

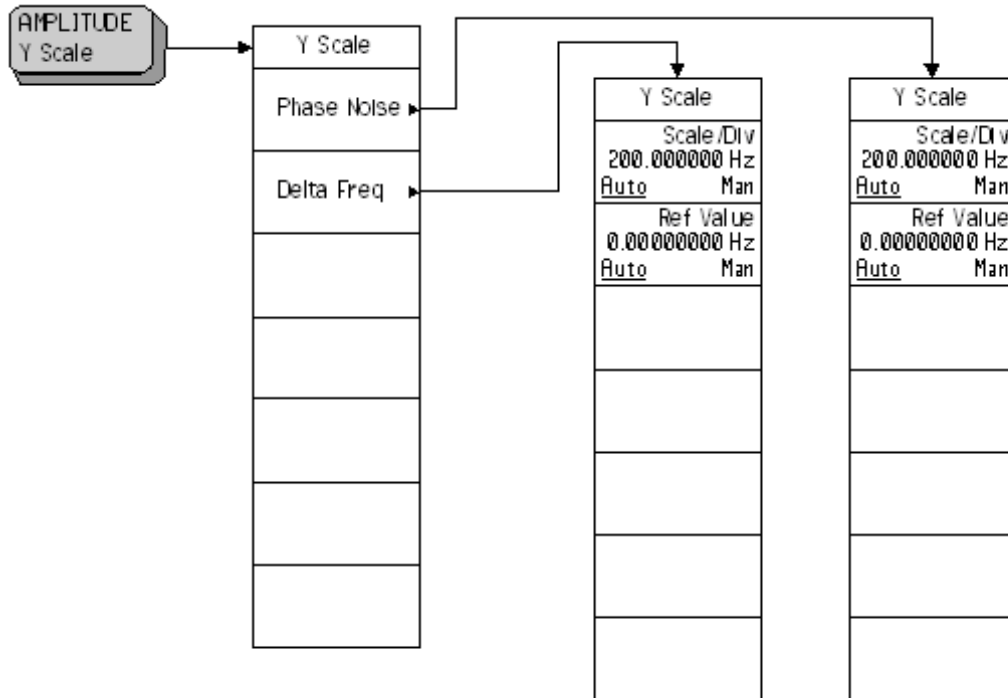

BW/Avg Menu

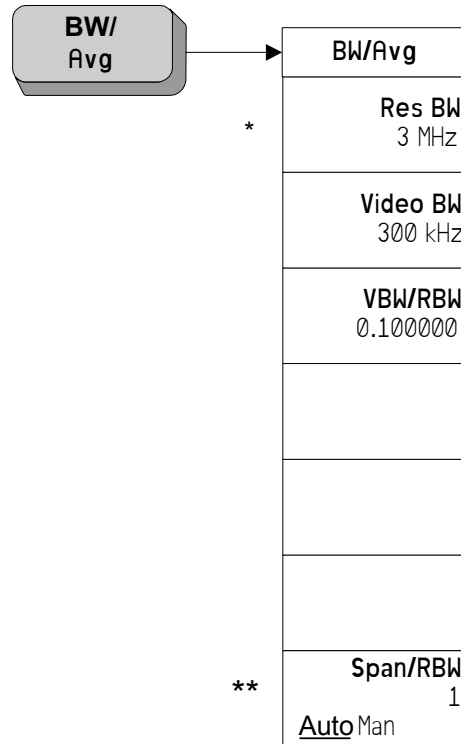

* Grayed out in Spot Frequency and Log Plot measurements.

** Grayed out in Spot Frequency measurements.

Det/Demod Menu - Log Plot and Spot Frequency



* Read only parameter.
Always grayed out.

Display Menu - Log Plot

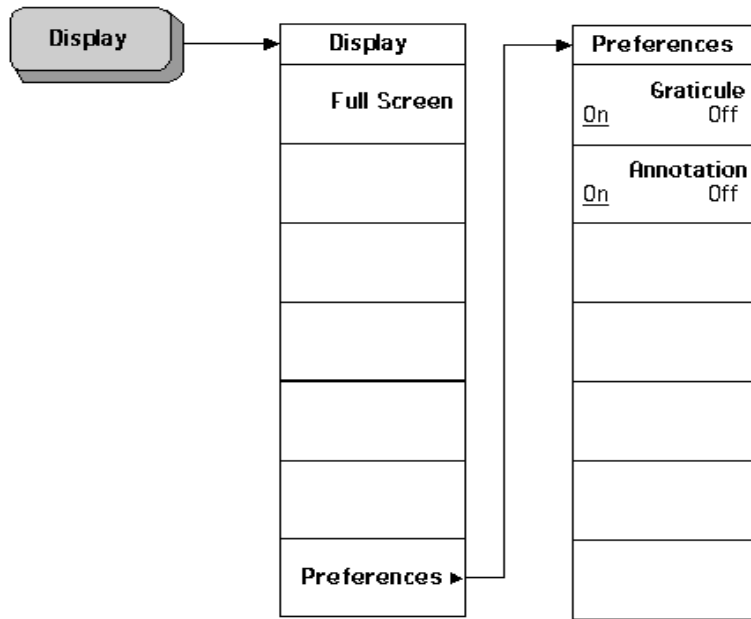

Display Menu - Monitor Spectrum

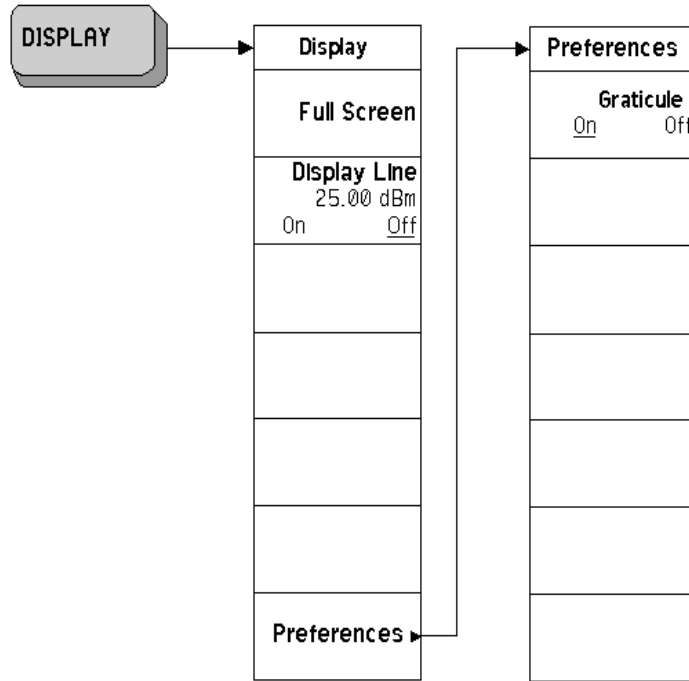

Display Menu - Spot Frequency

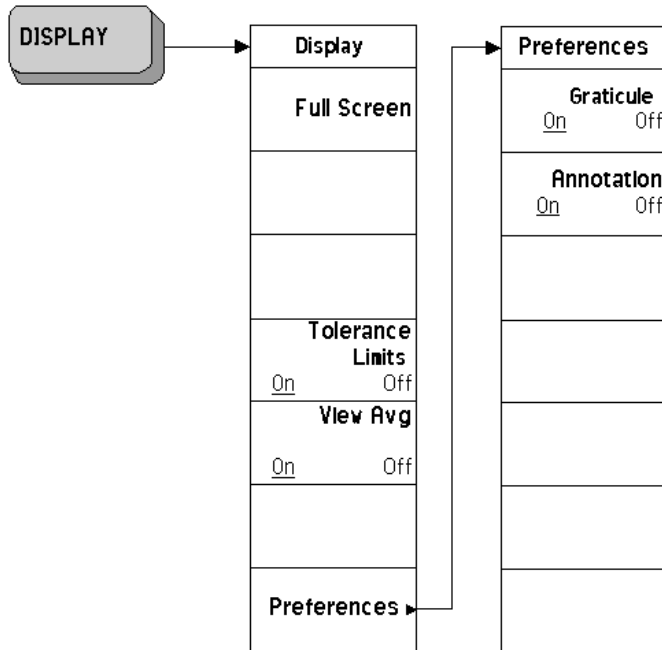

File Menu (1 of 6)

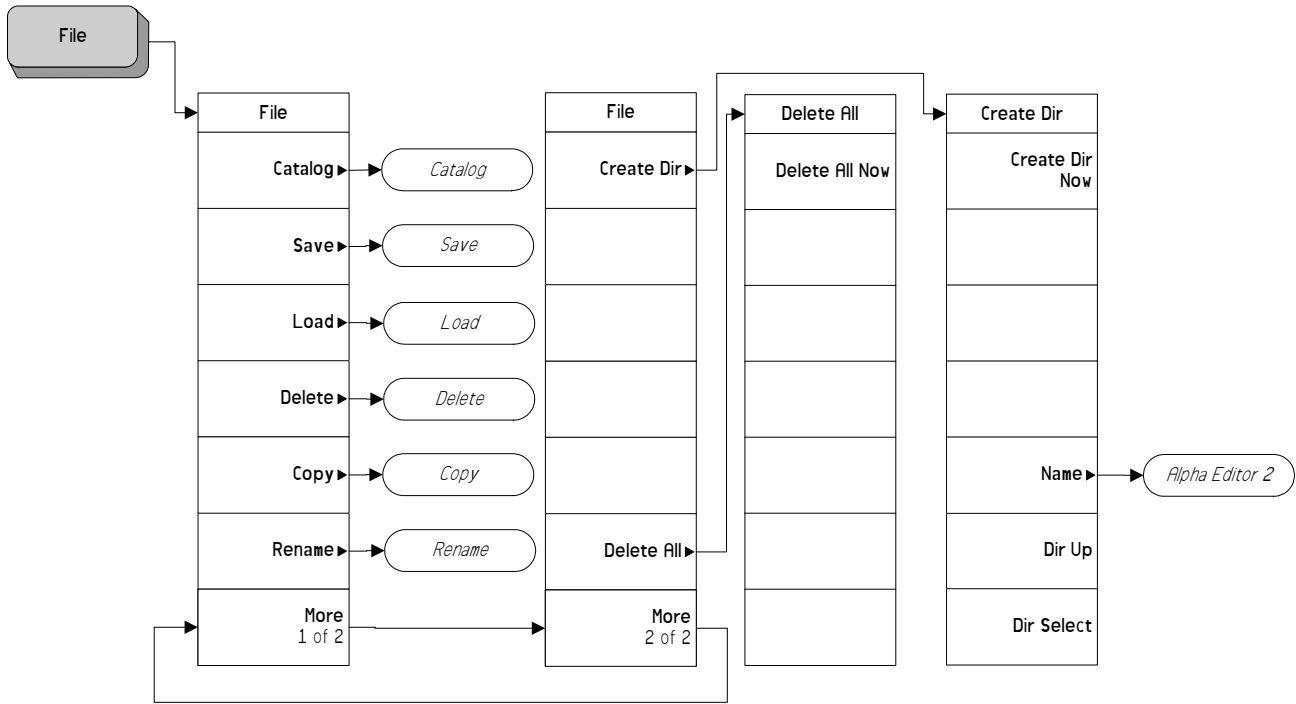

pe856a

File Menu (2 of 6)

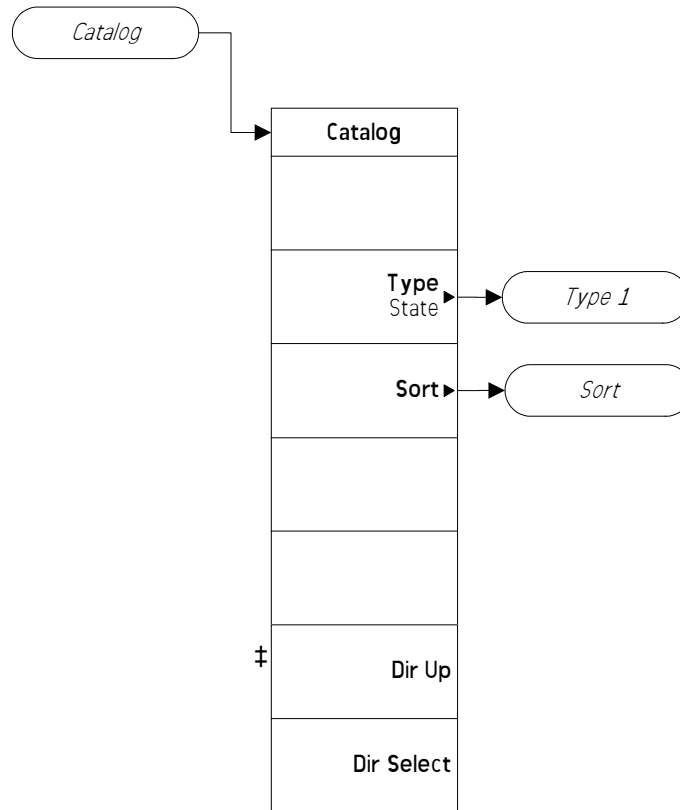

pe857a

File Menu (3 of 6)

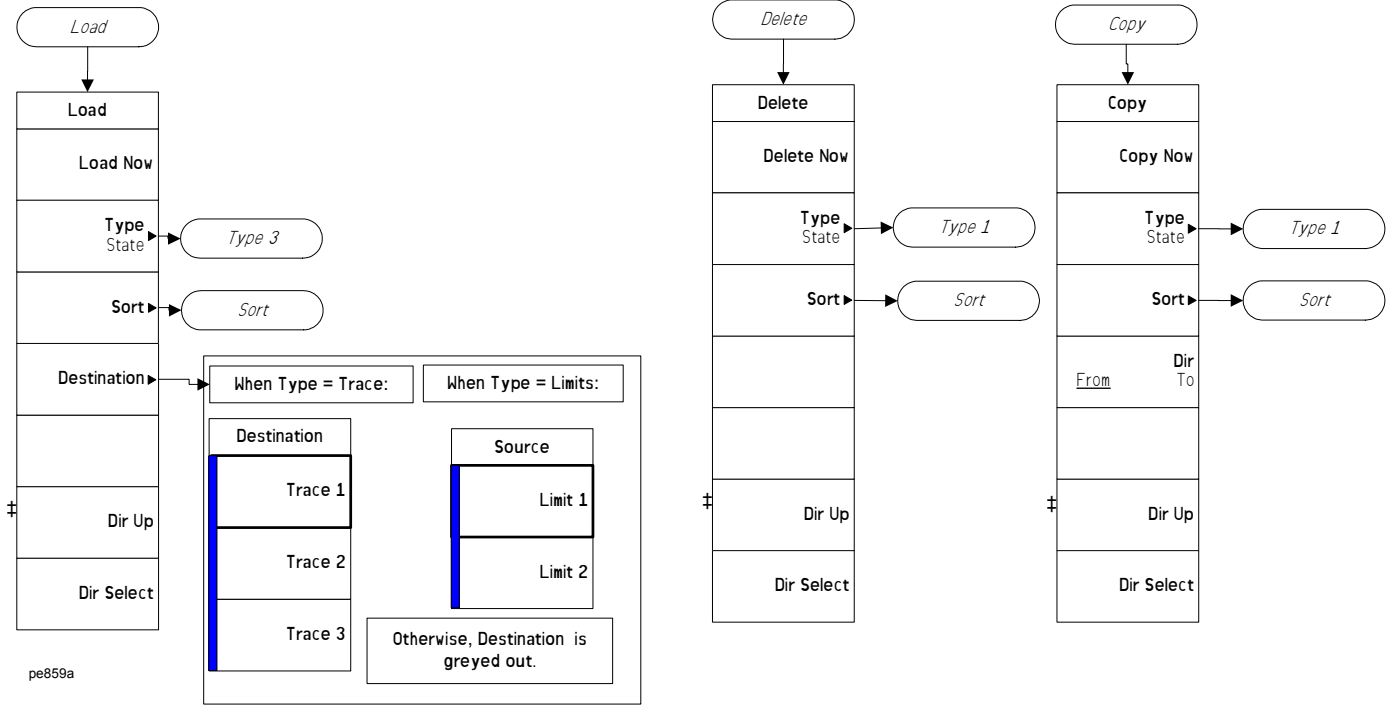

File Menu (4 of 6)

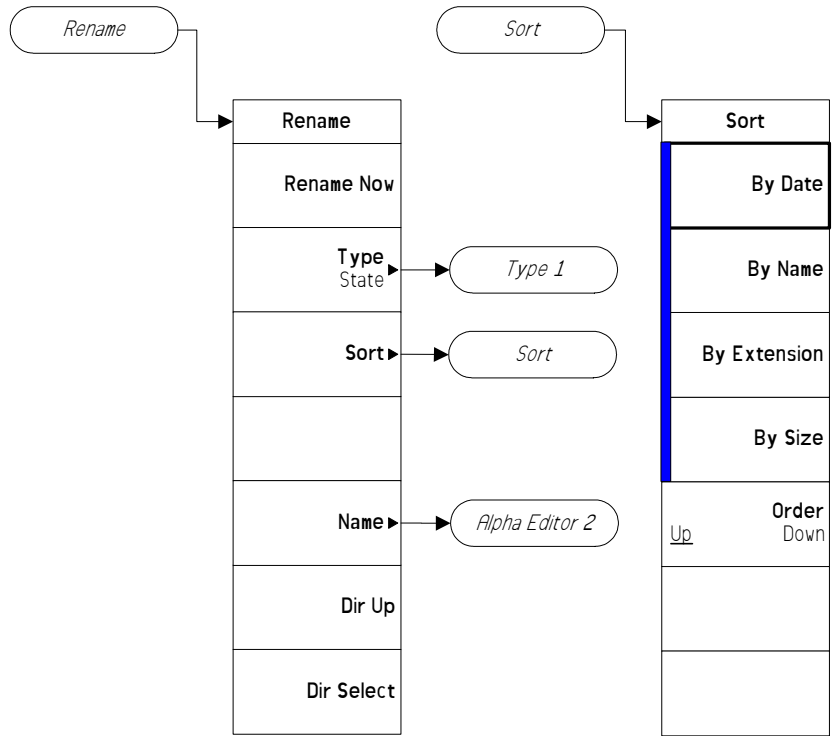

File (4)

File Menu (5 of 6)

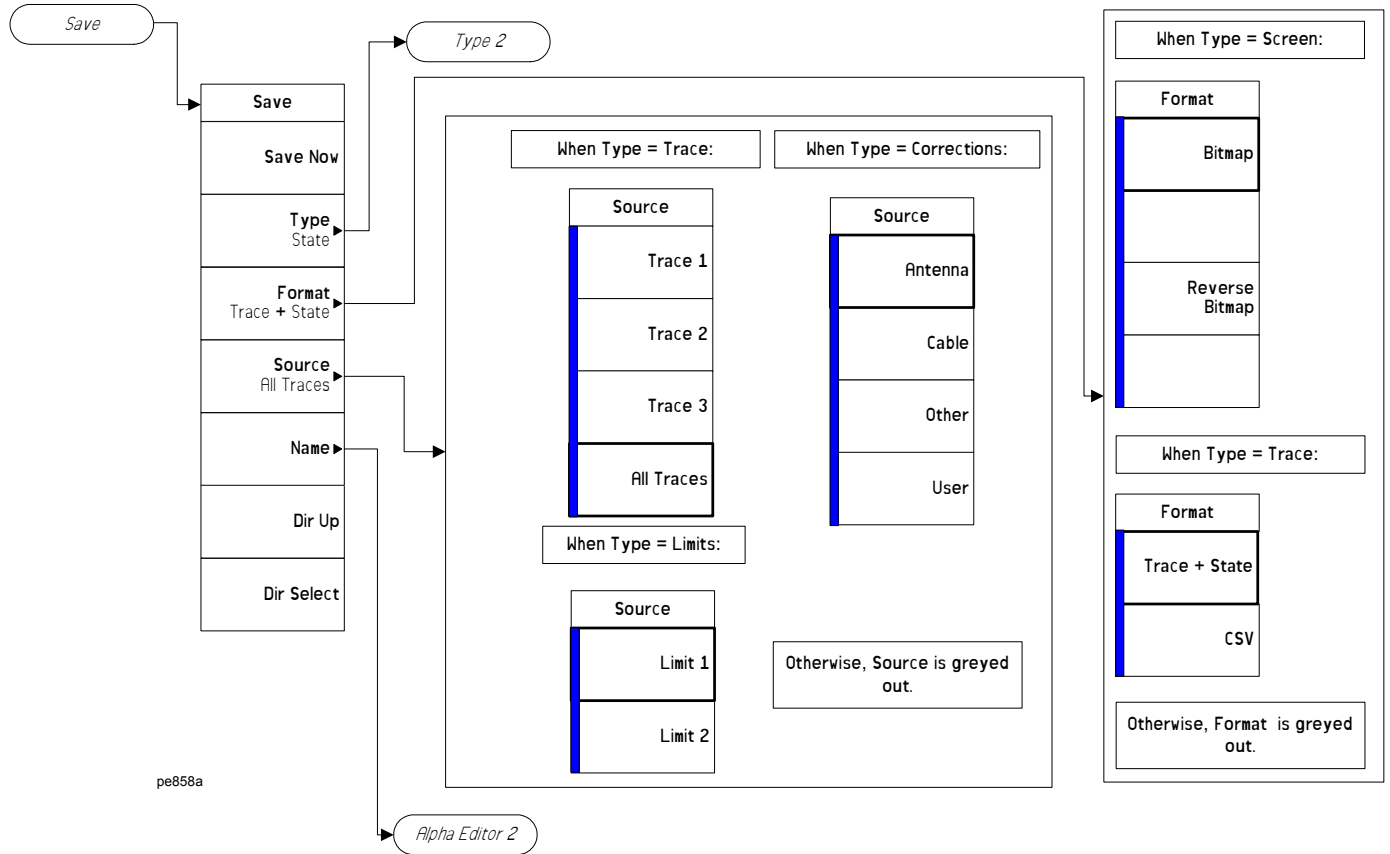

Frequency/Channel Menu

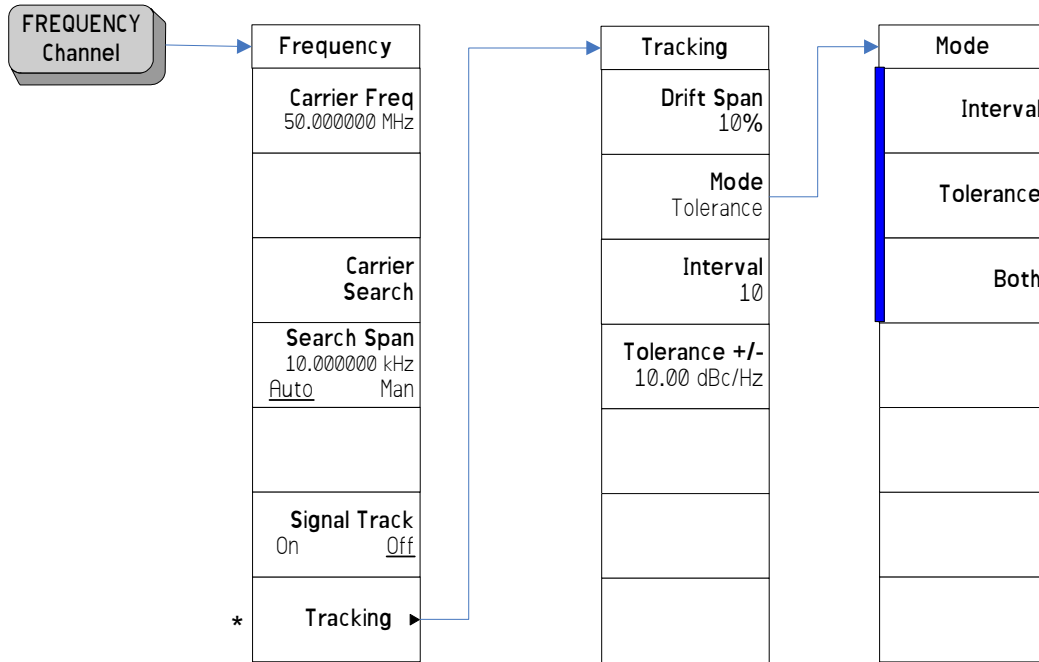

* Grayed out in Monitor and Log Plot Measurements.
Available only in Spot Frequency measurements.

■ A bar on the left of two or more softkeys indicates that the keys are a set of mutually exclusive choices.

Input Output Menu

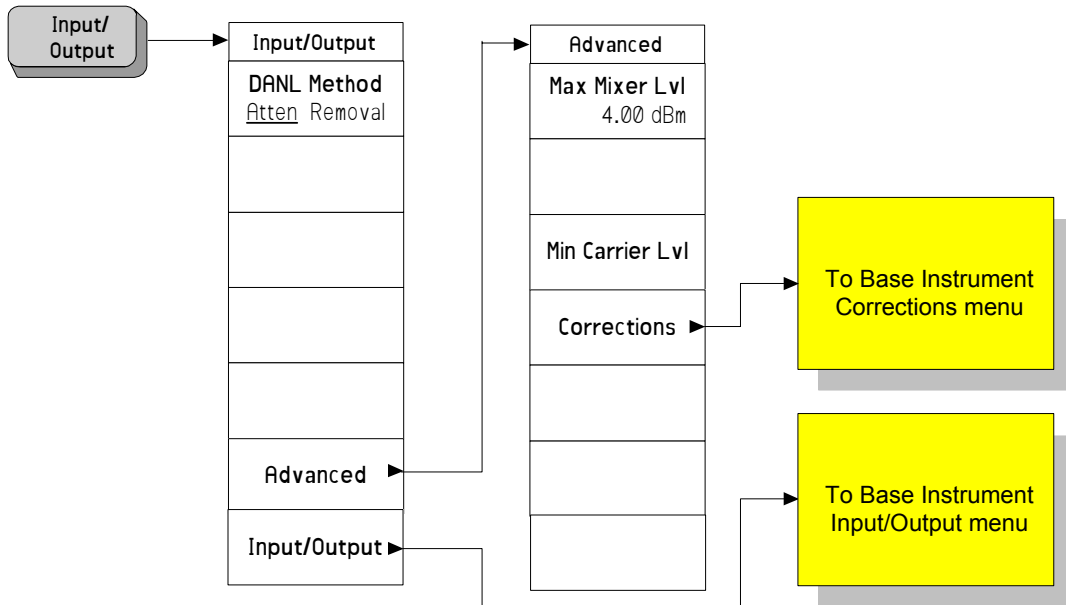

Marker Menu - Log Plot

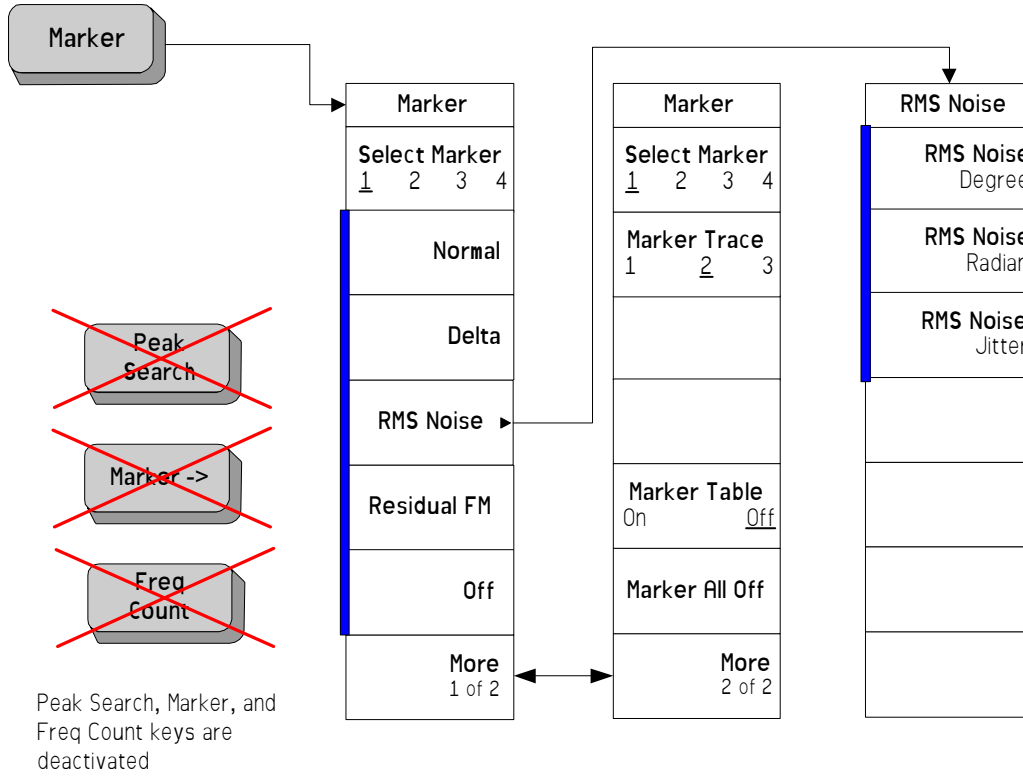

| A bar on the left of two or more softkeys indicates that the keys are a set of mutually exclusive choices.

Measure Menu

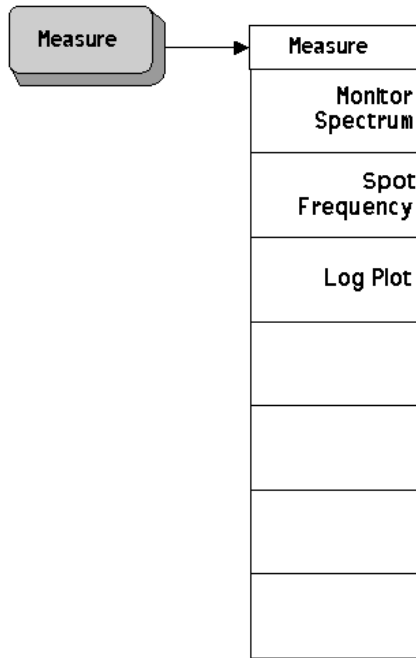

Meas Setup Menu - Log Plot

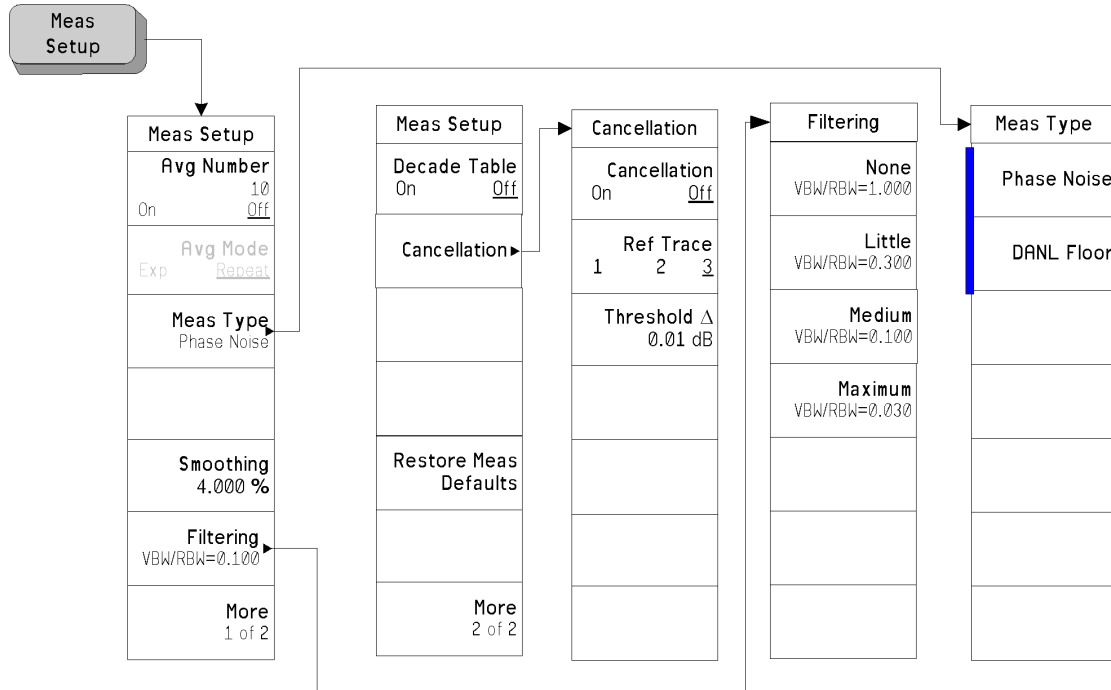

A bar on the left of two or more softkeys indicates that the keys are a set of mutually exclusive choices.

Meas Setup Menu - Monitor Spectrum

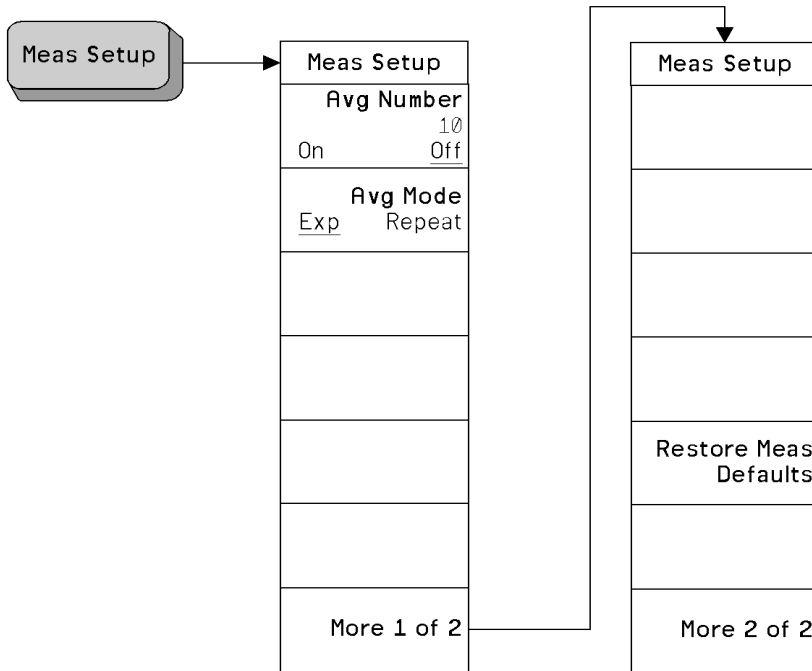

Meas Setup Menu - Spot Frequency

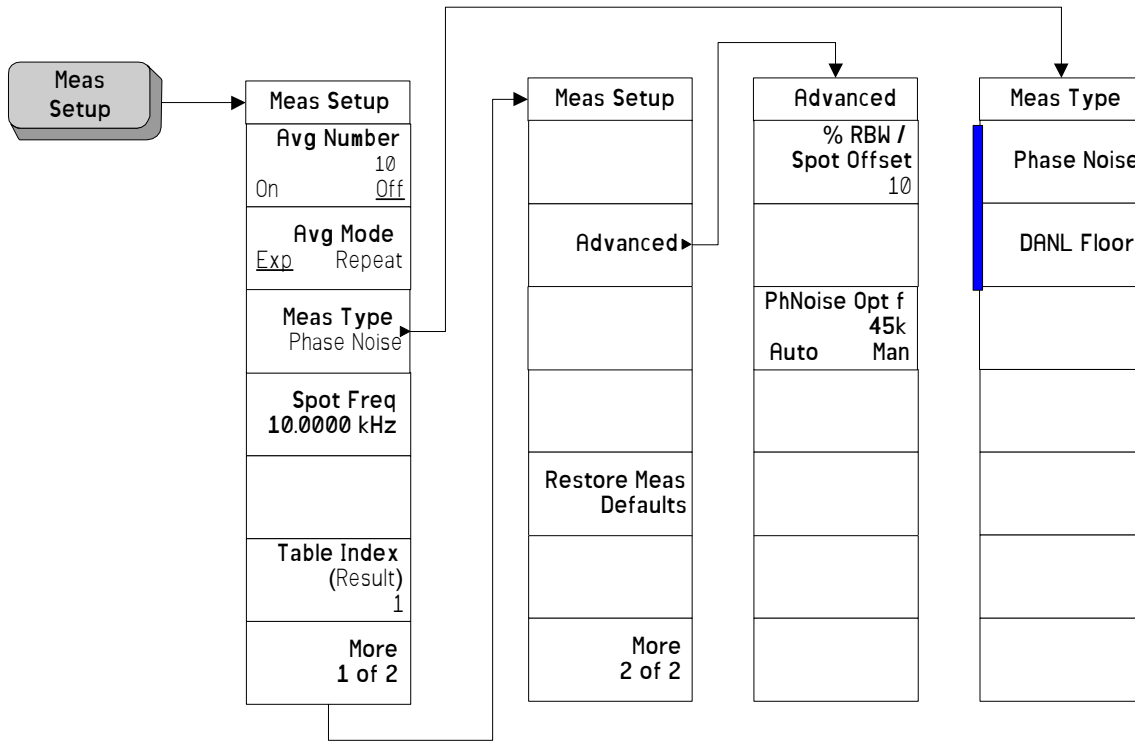

| A bar on the left of two or more softkeys indicates that the keys are a set of mutually exclusive choices.

Mode Menu

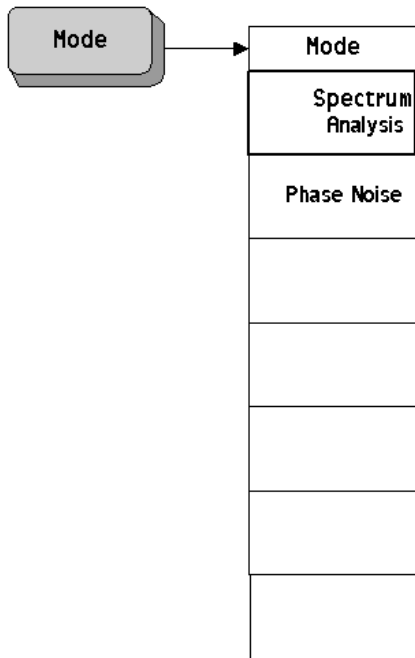

Mode Setup Menu

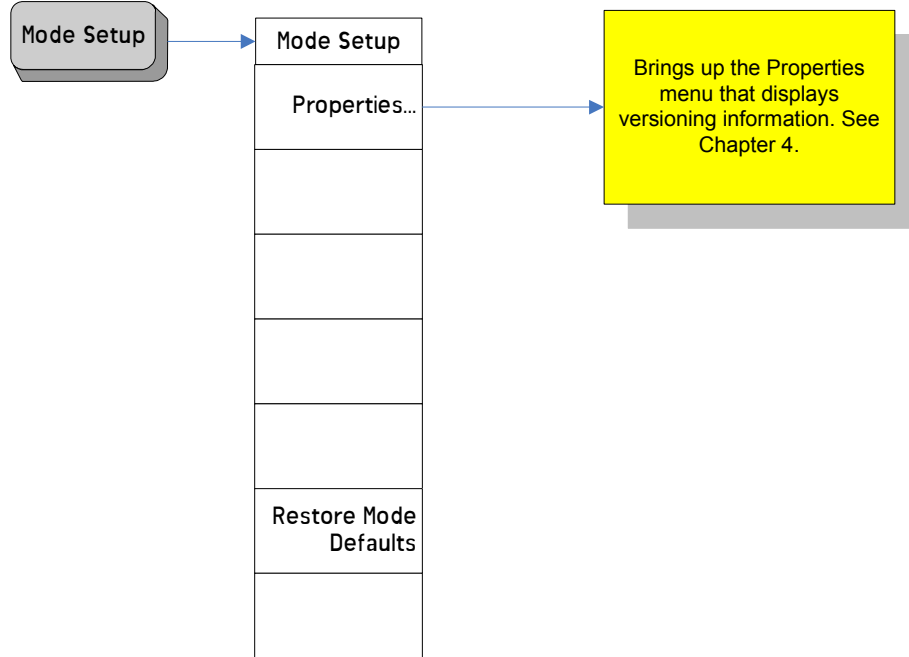

Span (X Scale) Menu - Log Plot



Span (X Scale) Menu - Monitor Spectrum

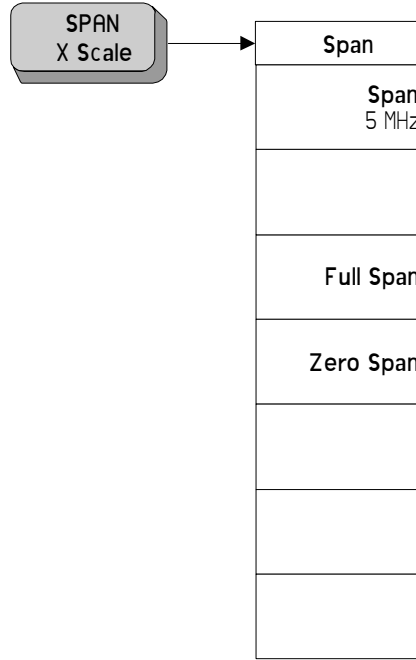

Span (X Scale) Menu - Spot Frequency

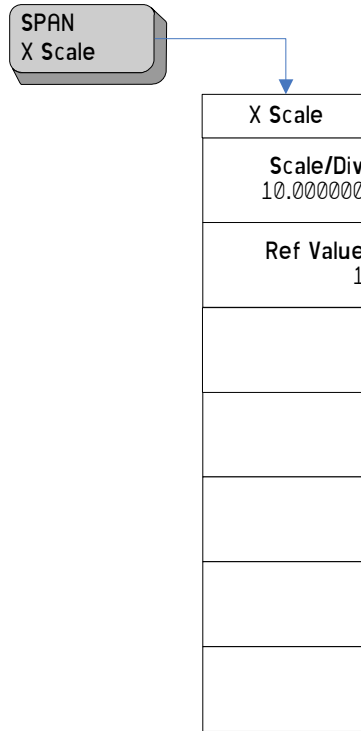

Sweep Menu - Log Plot

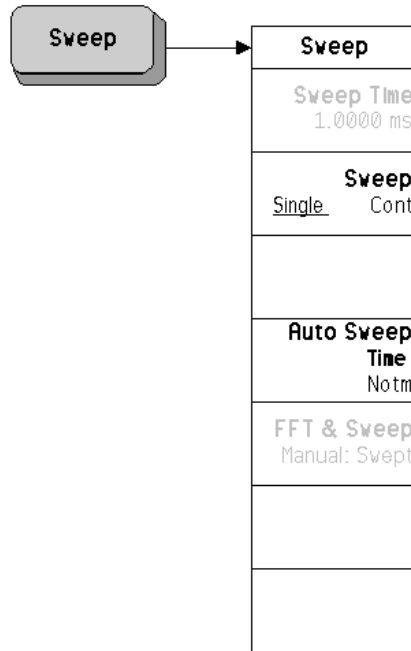

Sweep Menu - Spot Frequency

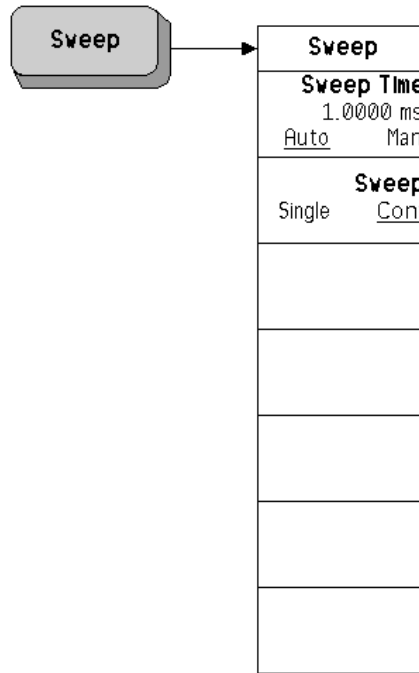

Trigger Menu

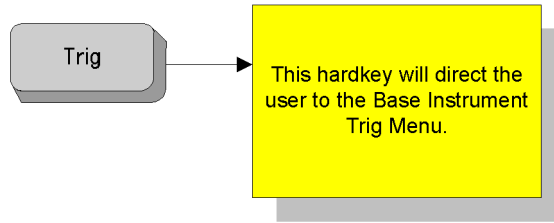

Trace/View Menu - Log Plot

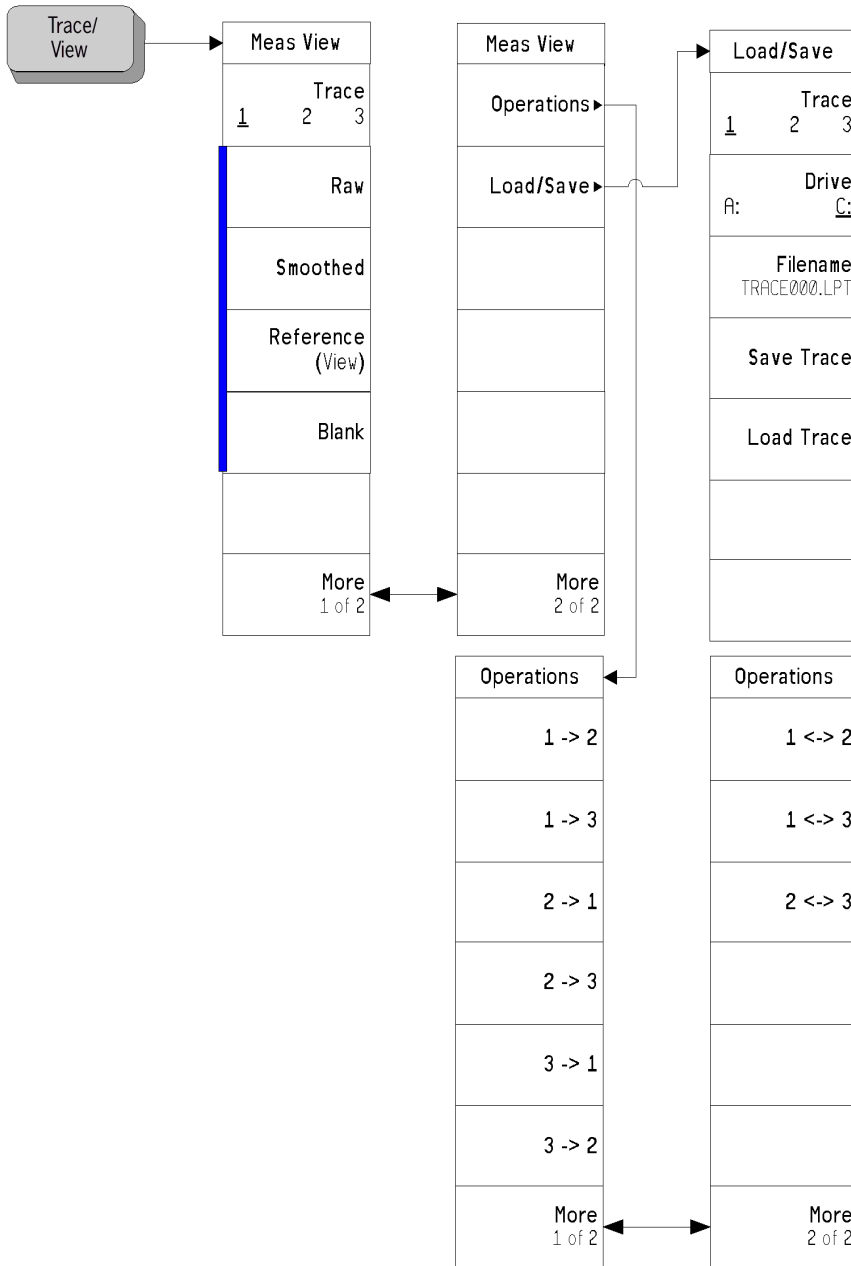

| A bar on the left of two or more softkeys indicates that the keys are a set of mutually exclusive choices.

Trace/View Menu - Monitor Spectrum

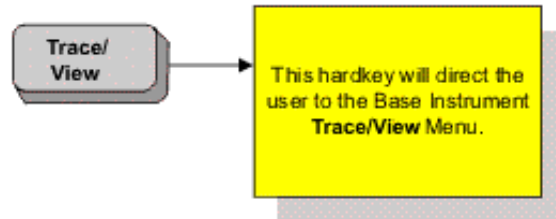

Trace/View Menu - Spot Frequency

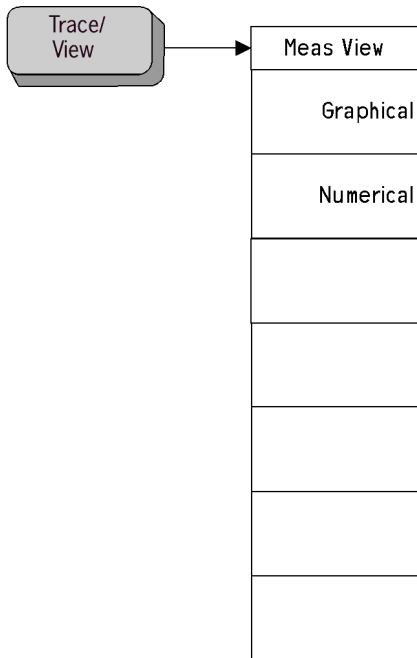

Menu Maps
Menus

4 Front-Panel Key Reference

This chapter details the front-panel keys and menu keys that appear on the menu-maps presented in the previous chapter. The front-panel keys are listed alphabetically and are described with their associated menu keys. The menu keys are arranged as they appear in your analyzer menus.

Key Descriptions and Locations

This chapter provides information on Phase Noise mode functions only. Some keys are described that are either not available in Spectrum Analysis (SA) mode, or that provide functions which differ from those provided by the same keys in SA mode. Other keys are described which provide fewer functions than the same key in SA mode, but the functions that are provided are identical in both modes. For those keys not described here, refer to the *PSA Series Spectrum Analyzers User's and Programmer's Reference Volume 1*.

AMPLITUDE Y Scale	Page 75
BW/Avg	Page 77
Det/Demod	Page 78
Display	Page 79
FREQUENCY Channel	Page 80
Input/Output	Page 82
Marker	Page 83
Meas Setup	Page 85
MEASURE	Page 89
MODE	Page 90
Mode Setup	Page 91
Preset	Page 92
SPAN X Scale	Page 93
Sweep Menu	Page 94
Trace/View	Page 95

AMPLITUDE Y Scale

Activates the reference level function, if it is available, and accesses the amplitude menu keys. Amplitude menu keys are used for setting functions that affect the way data on the vertical axis is displayed or corrected.

Monitor Spectrum Measurements

- Ref Level** Allows the reference level to be changed. The reference level is the amplitude (power or voltage) represented by the top graticule line of the display. Changing the reference level changes the absolute amplitude level (in the selected amplitude units) of the top graticule line. **Ref Level** can be changed using the step keys, the RPG knob, or the numeric keypad.
- Attenuator** Sets the input attenuation in 2 dB increments. The analyzer's input attenuator, which is normally coupled to the reference level control, reduces the power level of the input signal at the input mixer. The attenuator is recoupled when **Attenuation, Auto** is selected. **Attenuation, man** can be changed using the step keys, the RPG knob, or the numeric keypad.
- Scale/Div** Sets the logarithmic units per vertical graticule division on the display. **Scale/Div** values can vary between 0.1 dB and 20 dB per division.
- Optimize Ref Level** Automatically optimizes the reference level and the attenuation settings for the current signal. The attenuator is set to the lowest level that is needed to prevent damage to the input mixer, thus maximizing the signal's dynamic range. The reference level is set such that the signal's peak level is displayed in the top division of the graticule.

Log Plot Measurements

- Scale/Div** Allows you to specify the Y-scale units per division on the log plot display. You can set the value using the step keys, the RPG knob, or the numeric keypad.
- Ref Value** Allows you to specify the value (in dBc/Hz) of the reference level of the log plot display. (See **Ref Position**.)
- Ref Position** The reference position on each trace is indicated by a small chevron (the '>' and '<' signs) at either side of the graticule. The value in dBc/Hz of this reference position on the graticule is specified with the **Ref Value** softkey. The **Ref Position** softkey allows you to vary the position of the reference trace between top, center, and bottom of the graticule. This softkey is only available in Log Plot measurements.

- Top** Sets the reference position to the top line of the graticule. Its position is indicated by a small chevron on either side of the graticule.
- Ctr** Sets the reference position to the center of the graticule. Its position is indicated by a small chevron on either side of the graticule.
- Bot** Sets the reference position to the bottom line of the graticule. Its position is indicated by a small chevron on either side of the graticule.

Spot Frequency Measurements

Phase Noise

When **Signal Tracking** is **On** and a Spot Frequency measurement is being made, the screen is split vertically into two sections. The left half of the screen displays the Phase Noise of the signal being measured, while the right hand half, labelled 'Delta Freq', shows the changes in frequency of the signal. This key allows you to control the appearance of the Phase Noise display.

- Scale/Div** Sets the units per vertical graticule division on the display.
- Ref Value** Sets the value of the reference line on the screen. The reference line is shown in magenta pink.

Delta Freq

When **Signal Tracking** is **On** and a Spot Frequency measurement is being made, the screen is split vertically into two sections. The left half of the screen displays the **Phase Noise** of the signal being measured, while the right hand half, labelled '**Delta Freq**', shows the changes in frequency of the signal. This key allows you to control the appearance of the **Delta Freq** display.

- Scale/Div** Sets the units per vertical graticule division on the display.
- Ref Value** Sets the value of the reference line on the screen. The reference line is shown in magenta pink.

BW/Avg

This front-panel key accesses the menu keys that allow you to select different resolution and video bandwidth settings.

- Res BW** Allows you to select **Auto** or **Man** (manual) setting of the resolution bandwidth. When set to **Man**, you can change the **Res BW** using the front-panel keys or the RPG knob.
- Video BW** Allows you to select **Auto** or **Man** (manual) setting of the video bandwidth. When set to **Man**, you can change the **Video BW** using the front-panel keys or the RPG knob.
- VBW/RBW** Allows you to modify the ratio of video bandwidth to resolution bandwidth.
- Span/RBW** Allows you to select **Auto** or **Man** (manual) setting of the span to resolution bandwidth ratio. When set to **Man**, you can manually set the **Span/RBW** ratio.

Det/Demod

This key is only accessible when making a Monitor Spectrum measurement. Its menu is grayed out at all other times. Please refer to the *PSA Series Spectrum Analyzers User's and Programmer's Reference Volume 1* for further details.

Display

This front-panel key accesses the menu keys that allow you to see and setup different measurement displays.

- Full Screen** Extends the measurement window over the entire analyzer display, removing the softkey menu as it does so. To restore the softkey menu, press any key except **Print**, **Save**, or any of the data entry keys.

- Tolerance Limits** When you are tracking a drifting signal and the tracking mode is **Tolerance**, you can choose to display or hide the lines corresponding to the tolerance limits by using this key. This softkey is only available in Spot Frequency measurements.

- View Avg** Allows you to display or hide a line on the screen showing the moving average value. The line represents the average value of the measurements showing on the screen. This softkey is only available in Spot Frequency measurements.

- Preferences** This displays a further menu giving you control over some aspects of the display's appearance.
 - Graticule** Allows you to display or hide the graticule lines on the display.

 - Annotation** Allows you to display or hide some of the annotation pertaining to the current display. This softkey is only available in Spot Frequency and Log Plot measurements.

- Display Line** Activates an adjustable horizontal line that is used as a visual reference line. This line, which can be used for trace arithmetic, has amplitude values that correspond to its vertical position when compared to the reference level. To deactivate the display line, press **Display**, **Display Line Off**. This softkey is only available in Monitor Spectrum measurements.

FREQUENCY Channel

Accesses the menu of frequency functions.

Carrier Freq Allows you to specify the frequency of the signal whose phase noise is to be measured. As long as the frequency you enter is within plus or minus 5% of the carrier signal's true frequency, the analyzer will tune to it automatically.

Carrier Search Automatically tunes the analyzer to the strongest signal it can find. If **Search Span** is set to **Automatic**, the search is performed from a lower limit of 100 Hz to an upper limit of the analyzer's maximum capabilities. When **Search Span** is set to **Manual**, the search is performed within the frequency range specified in **Search Span**, centered on the current carrier frequency.

Search Span Determines the spectral range that a **Carrier Search** will search for a signal. This key toggles between **Automatic** and **Manual** settings, and when set to **Manual**, allows you to enter a frequency range manually. When **Search Span** is set to **Automatic**, the search is performed from a lower limit of 100 Hz to an upper limit of the analyzer's maximum capabilities. When **Search Span** is set to **Manual**, the search is performed within the frequency range specified here, centered on the current carrier frequency.

Signal Track Specifies whether or not the analyzer automatically tracks a slowly drifting signal.

On When **Signal Track** is set to **On**, the analyzer repeatedly measures the frequency of the carrier signal to check for any change that might have occurred, and retunes to the new frequency if necessary.

Off When this is set to **Off**, the analyzer makes its measurement at a fixed frequency.

NOTE The repeated realignment with the signal when tracking is **On** causes measurements to take longer than when tracking is **Off**.

Tracking Displays a menu which allows you to control exactly how signal tracking is performed. Spot Frequency measurement only. (Grayed out for all other measurements.)

Drift Span Specifies the span, as a percentage of the carrier frequency, within which the frequency drift will be tracked. For example, if a **Drift Span** of 12% is specified, the signal will be tracked as long as it remains within plus or minus 6% of the most recent frequency

measurement. The drift span is limited to a maximum of 50 MHz.

Mode

Displays a menu that allows control over how signal tracking operates. You can select from three modes of operation - **Interval**, **Tolerance** or a combination of the two.

Interval The analyzer will retune to the carrier signal after every **Interval** number of measurements have been made.

Tolerance The analyzer will retune to the carrier signal whenever one phase noise measurement differs from the average value by **Tolerance** percent.

Both This is a combination of **Interval** and **Tolerance** modes. The analyzer will retune to the carrier signal after every **Interval** number of measurements or whenever the latest phase noise measurement deviates from the average by **Tolerance** percent, depending on which occurs first.

Interval

The analyzer will retune to the carrier signal after every **Interval** number of measurements have been made.

Tolerance +/-

The analyzer will retune to the carrier signal whenever one phase noise measurement differs from the average value by **Tolerance** percent. The tolerance limits are displayed on the screen by parallel green lines.

Input/Output

Displays a menu that allows you to control how noise levels are to be measured and gives you access to the advanced menu.

DANL Method

Allows you to select one of two alternative methods of measuring the Displayed Average Noise Level (**DANL**).

Atten The **Attenuation** method attenuates any incoming signal to such an extent that it is almost lost within the background noise. The noise level can then be measured.

Removal The **Removal** method of measuring **DANL** requires the input signal to be physically disconnected from the analyzer before the noise level is measured. The analyzer will tell you when to remove or disconnect the signal, and when to reconnect it afterwards.

NOTE

Every analyzer generates some noise of its own. By measuring this noise level, you can compensate for it and thus obtain more accurate phase noise measurements. The **Attenuation** method of **DANL** measurement is accurate enough for most purposes and is generally more convenient, but the **Removal** method is the more accurate.

Advanced

Gives you access to the **Advanced** menu of Input functions.

Max Mixer Level Allows you to control the maximum signal level at the mixer. For wide offset (greater than 1 MHz) phase noise measurements, increasing the maximum mixer level towards its compression point maximizes the measurement range.

Min Carrier Lvl Allows you to set the minimum level anticipated for your measurement. This is particularly important when using an external mixer which has high conversion loss. The error message, "Carrier not found/peak not found" is displayed if the carrier level is below the **Min Carrier Lvl** setting.

Corrections Allows you to set corrections.

Input/Output

Displays the basic spectrum analyzer's Input/Output menu. Refer to the *PSA Series Spectrum Analyzers User's and Programmer's Reference Volume 1* for more information.

Marker

Displays a menu that allows you to set each of the four markers to mark, or display, a particular measurement.

Monitor Spectrum Measurements

Displays the basic spectrum analyzer's **Marker** menu. Please refer to the *PSA Series Spectrum Analyzers User's and Programmer's Reference Volume 1* for more information.

Spot Frequency Measurements

Marker functionality is not available for Spot Frequency measurements.

Log Plot Measurement

The following marker keys are available for Log Plot measurements:

- Select Marker** Allows you to select one of the four possible markers. Having selected one of the markers, use the other softkeys on this menu to specify the type of marker or measurement.

- Normal** Sets the specified marker to be a normal marker. That is, it marks the point of the frequency offset that you specify, and then the analyzer measures and displays the phase noise at this point.

- Delta** A delta marker is actually a pair of markers. By pressing Delta, you set a pair of markers at your current frequency offset. One of this pair of markers (indicated by an 'R' on the display) is fixed while the second of the pair can be moved using your RPG knob or the numeric keys. The frequency difference and the phase noise difference between these two points is displayed.

- RMS Noise** Displays a second menu allowing access to three RMS noise functions. An RMS Noise marker is actually a pair of markers. By pressing RMS Noise Degrees, you get a pair of markers at your current frequency offset. One of this pair of markers (indicated by an 'R' on the display) is fixed while the second of the pair can be moved using your RPG knob or the numeric keys.
 - RMS Noise Degrees** The root mean square (RMS) of the phase noise between these two points is calculated, and is displayed in degrees.

Marker**RMS Noise**

Radians The root mean square (RMS) of the phase noise between these two points is calculated, and is displayed in radians.

RMS Noise

Jitter The root mean square (RMS) of the jitter between these two points is calculated, and is displayed in units of time, typically in picoseconds ('ps' or 10^{-12} sec) or femtoseconds ('fs' or 10^{-15} sec).

Residual FM A Residual FM marker is actually a pair of markers. By pressing Residual FM, you set a pair of markers at your current frequency offset. One of this pair of markers (indicated by an 'R' on the display) is fixed while the second of the pair can be moved using your RPG knob or the numeric keys. The root mean square (RMS) of the residual FM between these two points is calculated and displayed.

Off Switches the specified marker off.

Marker Trace Allows you to select which of the three traces your currently selected marker is applied to.

Marker Table Allows you to display all of the data from all of your markers in a tabular form. For every marker you have set, the table shows the number of the trace to which it has been applied, the marker's position on the X axis, and its measured Y axis value. As an aid to interpretation, each marker's trace number is displayed in the same color as the trace itself, that is yellow for trace 1, cyan blue for trace 2, and magenta pink for trace 3.

On Sets the marker table on. The table is displayed beneath the graticule.

Off Sets the marker table display off.

Marker All Off Switches all markers off. All markers are removed from the graticule display, and if the marker table is also displayed, all entries are removed from the table.

Meas Setup

Displays a menu that allows you to enter custom setup parameters for a measurement. The setup menu displayed depends on whether the Monitor Spectrum, Spot Frequency or the Log Plot measurement was selected in the **MEASURE** menu. Some keys are the same as in the basic Spectrum Analyzer mode. Refer to the *PSA Series Spectrum Analyzers User's and Programmer's Reference Volume 1* for more information on these keys.

Avg Number	<p>Allows you to specify the number of measurements to be averaged. After the specified number of average counts, the Avg Mode setting determines the averaging action. You can also set the averaging function to On or Off.</p> <p>On Enables the measurement averaging.</p> <p>Off Disables the measurement averaging.</p>
Avg Mode	<p>Allows you to select the type of termination control used for the averaging function. This determines the averaging action after the specified number of measurements (average count) is reached. Available for Monitor Spectrum and Spot Frequency measurements only. This key is grayed out and set to "REPeat" for Log Plot measurements.</p> <p>Exp After the average count is reached, each successive data acquisition is exponentially weighted and combined with the existing average.</p>
NOTE	<p>The Exponential average mode is not available when Phase Noise optimization f Mode is On (see PhNoise Opt f) and the spot frequency offset is between 40 kHz and 60 kHz.</p> <p>Repeat After the average count is reached, the averaging is reset and a new average is started.</p>
Restore Meas Defaults	<p>Sets up the analyzer parameters for the measurement using the factory default analyzer settings. (This only affects measurement parameters for this measurement and does not affect any mode parameters.) If you have made any manual changes to the measurement parameters, restoring the measurement defaults will ensure valid measurements.</p>
Meas Type	<p>Provides the menu keys that allow you to specify whether you want to measure the Phase Noise of a signal or the DANL Floor of the analyzer. Available for Log Plot and Spot Frequency measurements only.</p> <p>Phase Noise Specifies that the analyzer is to measure the phase noise of an input signal.</p>

DANL Floor Specifies that the analyzer's DANL (Displayed Average Noise Level) floor is to be measured.

Spot Offset Determines the frequency offset at which the phase noise is to be measured. Available for Spot Frequency measurements only.

Table Index The analyzer can hold and display the last 101 phase noise measurements. A subset of 22 of these 101 measurement values can be viewed as a table by selecting the **Numerical** option from the **Trace/View** menu. By specifying the **Table Index**, you can determine which of the measurement results are displayed. Your selected measurement, referred to by its **Table Index** number, is highlighted in yellow. Available for Spot Frequency measurements only.

Advanced Provides access to the Advanced menu of setup functions. Available for Spot Frequency measurements only.

PhNoise Opt f Used to select the offset frequency (measured relative to the carrier signal) at which the analyzer switches internal filters to make its phase noise measurement. If set to **Auto**, the analyzer will repeat the phase noise measurement with the crossover frequency both above and below your measurement offset, and will display the more accurate of the two measurements. You cannot improve on the measurement's accuracy by setting this to **Manual**, but you can improve the speed of the measurement.

NOTE The analyzer uses one of two different filters when measuring phase noise. One filter gives more accurate results at small offsets, and the other filter is more accurate at larger offsets. You can manually specify whether you wish the crossover point between these two filters to be above or below your measurement offset. If you make two measurements on the same signal, one with the crossover point below your measurement offset and the other one with it above your signal, the lower figure will be the more accurate.

RBW/Spot Offset The resolution bandwidth is specified as a percentage of the spot offset frequency. This key allows you to specify that percentage figure.

Smoothing Allows you to specify the amount of smoothing done to the trace after the measurement has been performed. The amount of smoothing can be varied between 0.00% and 16.0%. By default, both the trace of the raw data and the smoothed trace are displayed. Available for Log Plot measurements only.

Filtering Allows you to specify whether or not to apply filtering to the signal. If

you do select filtering, there are four levels from which you can select: **none**, **little**, **medium**, and **maximum**. Available for Log Plot measurements only.

None	No filtering is performed. The video bandwidth to resolution bandwidth ratio (VBW/RBW) is fixed at 1.000.
Little	A small amount of filtering is performed. The video bandwidth to resolution bandwidth ratio (VBW/RBW) is fixed at 0.300.
Medium	A moderate amount of filtering is performed. The video bandwidth to resolution bandwidth ratio (VBW/RBW) is fixed at 0.100.
Maximum	A large amount of filtering is performed. The video bandwidth to resolution bandwidth (VBW/RBW) is fixed at 0.030.

NOTE Smoothing is faster than Filtering. However, there is a risk with smoothing that you might hide sudden changes in amplitude that might occur over a very small frequency range.

Decade Table Allows you to toggle the Decade Table **On** and **Off**. The **Decade Table** is a table of measurements that shows, for each of the analyzer's three traces (3 max.), the value in dBc/Hz at the point where the traces cross each decade line on the display. Available for Log Plot measurements only.

Cancellation If you have acquired a **DANL** trace from the analyzer, or a trace taken from a very clean source at the same frequency range that you are measuring, then you can automatically subtract this from your measurement. This softkey displays a submenu allowing you to perform this type of automatic noise cancellation. Available for Log Plot measurements only.

Cancellation Allows you to switch the automatic noise cancellation feature **On** or **Off**.

Ref Trace Allows you to specify which of the three traces holds the reference trace data. This data is automatically subtracted from your phase noise measurement when **Cancellation** is switched **On**.

NOTE For a trace to be used as a **Ref Trace**, it must be in **Reference (View)** mode, and must cover the same range of frequencies as those currently being measured.

Threshold Allows you to specify the threshold level for noise

cancellation. This value represents the minimum difference that must exist at each frequency point between the reference trace and the measured trace for one to be subtracted from the other.

MEASURE

Accesses menu keys that allow you to make Monitor Spectrum, Spot Frequency and Log Plot measurements.

Monitor Spectrum

Displays the frequency spectrum.

Spot Frequency

Measures the phase noise of the input signal at one discrete frequency offset.

Log Plot

Displays a logarithmic plot of the measured phase noise over a range of frequency offsets.

MODE

Accesses menu keys allowing you to select the measurement mode of your analyzer. Additional measurement personality software must be installed and activated in the analyzer for the other mode softkeys to be labeled and functional.

Spectrum Analysis

Accesses the spectrum analyzer menu keys and associated functions.

Phase Noise

Accesses the Phase Noise measurement personality menu keys and associated functions. This allows you to setup and make valid Phase Noise measurements.

NOTE

This menu will have additional entries if other personalities have been installed, for example GSM Option 202 or cdmaOne Option BAC.

Mode Setup

Accesses a menu allowing you to view information about the Phase Noise application and to set the phase noise measurement parameters back to their factory default settings.

Properties

Displays the Phase Noise application version number.

Restore Mode Setup Defaults

Sets up the spectrum analyzer's parameters for the mode using the factory default mode settings.

Preset

Provides a convenient starting point for making most measurements.

Depends on the preset type setting (user, mode, or factory) in the **System** keys. If the preset type is set to **Factory**, pressing **Preset** results in an immediate analyzer preset to the factory defaults. If it is set to **User**, pressing **Preset** accesses a menu that allows you choose your preset settings from either the factory default values or the settings you have previously defined as the **User** preset state.

User Preset

Restores the analyzer to a user defined state. The state was defined from the **System** key menu when the **Power On/Preset** function was selected and **Save, User Preset** was pressed. If you did not save a user state, then the current power-up state is stored as the user preset file for use when **Preset** is pressed.

Factory Preset

A full factory preset is executed so the analyzer is returned to the factory default state. The preset type can be set to **Factory** from the **Power On/Preset** function in the **System** key menu.

Mode Preset

Restores the mode defaults of the current mode, or of the mode that was in use when the analyzer was turned off or powered down. See the *PSA Series Spectrum Analyzers User's and Programmer's Reference Volume 1* for more details.

SPAN X Scale

Monitor Spectrum Measurements

Span	Allows you to change the frequency span symmetrically about the center frequency. To determine the frequency span per vertical graticule division, divide the frequency span by 10.
Full Span	Sets the span back to the analyzer's full range and adjusts the center frequency accordingly. Pressing Full Span turns Signal Track off.
Zero Span	Changes the frequency span to zero. Pressing Zero Span turns Signal Track off.

Log Plot Measurements

Start Offset	Allows you to specify the offset frequency at which your Log Plot measurement will start.
Stop Offset	Allows you to specify the offset frequency at which your Log Plot measurement will stop.

Spot Frequency Measurements

Scale/Div	Although the Spot Frequency display appears to be showing a continuously moving plot, it is actually made up of a number of discrete individual measurements plotted over time. This softkey allows you to specify how many measurements will be plotted between each successive division on the graticule.
------------------	---

NOTE Scale/Div affects both the phase noise display and the delta freq display simultaneously.

Ref Value	The analyzer stores up to 101 measurement values which it updates continually. These values are then used to generate the plot on the screen. If you are displaying fewer than the full 101 measurements (in other words, you have set Scale/Div (above) to less than 10), you can use this softkey to specify the measurement number with which your display is to start.
------------------	--

NOTE Ref Value affects both the phase noise display and the delta freq display simultaneously.

Sweep Menu

- Sweep Time** Allows you to specify the sweep time for your measurement. This key is grayed out in Log Plot measurements as the best setting is automatically calculated for each linear segment.
- Sweep** Specifies whether the analyzer sweeps (or measures) continually, or whether it performs a single sweep and then stops.
- Single** The analyzer performs one single measurement and then stops. You have to press the **Restart** button every time you want to make another measurement.
 - Cont** The analyzer continuously measures the signal it is receiving and repeatedly updates the plots and the measurements.
- Auto Sweep Time** Lets the analyzer automatically select the sweep time. Refer to the *PSA Series Spectrum Analyzers User's and Programmer's Reference Volume 1* for more information.
- FFT & Sweep** Allows you to select **Manual** or **Swept** for Monitor Spectrum and Spot Frequency measurements. This key is grayed out in Log Plot measurements as the best setting is automatically calculated for each linear segment.

Trace/View

Accesses the **Trace/View** menu keys that allow you to set the way the measurement result information is displayed. The menu options will vary depending on the measurement that is selected under the **Measure** menu. If **Sig ID** is **On**, the **Trace/View** menu is unavailable.

Monitor Spectrum Measurements

Refer to the *PSA Series Spectrum Analyzers User's and Programmer's Reference Volume 1*.

Log Plot Measurements

Trace	Allows you to select any of the three traces to then specify its characteristics.																		
Raw	The trace selected in Trace (above) records and displays the raw measurement data.																		
Smoothed	The trace selected in Trace (above) records and displays the smoothed measurement data.																		
Reference (View)	The trace selected in Trace (above) is set to Reference (View) . You can see its display on the screen. Trace 1 displays in yellow, trace 2 in cyan blue, and trace 3 in magenta pink.																		
Blank	The trace selected in Trace (above) is blanked out on the screen so you can no longer see it.																		
Operations	Selects a menu allowing you to move data between traces.																		
	<table> <tr> <td>1 -> 2</td> <td>Copies the data in Trace 1 to Trace 2.</td> </tr> <tr> <td>1 -> 3</td> <td>Copies the data in Trace 1 to Trace 3.</td> </tr> <tr> <td>2 -> 1</td> <td>Copies the data in Trace 2 to Trace 1.</td> </tr> <tr> <td>2 -> 3</td> <td>Copies the data in Trace 2 to Trace 3.</td> </tr> <tr> <td>3 -> 1</td> <td>Copies the data in Trace 3 to Trace 1.</td> </tr> <tr> <td>3 -> 2</td> <td>Copies the data in Trace 3 to Trace 2.</td> </tr> <tr> <td>1 <-> 2</td> <td>Swaps the data in Trace 1 and Trace 2.</td> </tr> <tr> <td>1 <-> 3</td> <td>Swaps the data in Trace 1 and Trace 3.</td> </tr> <tr> <td>2 <-> 3</td> <td>Swaps the data in Trace 2 and Trace 3.</td> </tr> </table>	1 -> 2	Copies the data in Trace 1 to Trace 2.	1 -> 3	Copies the data in Trace 1 to Trace 3.	2 -> 1	Copies the data in Trace 2 to Trace 1.	2 -> 3	Copies the data in Trace 2 to Trace 3.	3 -> 1	Copies the data in Trace 3 to Trace 1.	3 -> 2	Copies the data in Trace 3 to Trace 2.	1 <-> 2	Swaps the data in Trace 1 and Trace 2.	1 <-> 3	Swaps the data in Trace 1 and Trace 3.	2 <-> 3	Swaps the data in Trace 2 and Trace 3.
1 -> 2	Copies the data in Trace 1 to Trace 2.																		
1 -> 3	Copies the data in Trace 1 to Trace 3.																		
2 -> 1	Copies the data in Trace 2 to Trace 1.																		
2 -> 3	Copies the data in Trace 2 to Trace 3.																		
3 -> 1	Copies the data in Trace 3 to Trace 1.																		
3 -> 2	Copies the data in Trace 3 to Trace 2.																		
1 <-> 2	Swaps the data in Trace 1 and Trace 2.																		
1 <-> 3	Swaps the data in Trace 1 and Trace 3.																		
2 <-> 3	Swaps the data in Trace 2 and Trace 3.																		

NOTE When data is stored in a trace, that trace is set to **Reference (View)** mode.

Load/Save Accesses a menu allowing you to load stored trace data to the analyzer, and to save trace data to files.

Trace Specifies which of the three traces you wish to save or load.

Drive Specifies which drive (that is, which disk) you wish to load data from or store data to. 'Drive A:' is a floppy disk and 'C:' is the analyzer's hard disk.

Filename Displays the alphabetic editor allowing you to specify the name of the file that you wish to load or save. The file extension .LPT is automatically added to the name you type.

Save Trace Saves the trace that you selected to the filename and drive (disk) that you specified. The filename has the extension .LPT added automatically.

Load Trace Takes the filename from the drive (disk) that you specified, and loads the data into the trace that you have selected.

Spot Frequency Measurements

Graphical Measurement data is displayed graphically, and only the most recent measurement value is displayed numerically. If signal tracking has been switched on, a graphical display of the change in frequency is shown alongside the phase noise plot.

Numerical A subset of 22 of the 101 measurements is shown in a table to the left of the display. The phase noise plot is still shown, but the delta frequency display is removed, regardless of whether signal tracking is switched on or off.

5 Language Reference

These commands are only available when the Phase Noise mode has been selected using analyzer :SElect or analyzer :NSElect. If the Phase Noise mode is selected, commands that are unique to another mode are not available.

CALCulate Subsystem

This subsystem is used to perform post-acquisition data processing. In effect, the collection of new data triggers the CALCulate subsystem. In this instrument, the primary functions in this subsystem are markers and limits.

The SCPI default for the data output format is ASCII. The format can be changed to binary with FORMat:DATA which transports faster over the bus.

CALCulate:LPLot Subsystem

The Log Plot measurement shows a graph of the phase noise power plotted versus the log of the frequency offset from the carrier.

Decade Table On/Off

```
:CALCulate:LPLot:DECade:TABLE[:STATE] OFF|ON|0|1
```

```
:CALCulate:LPLot:DECade:TABLE[:STATE] ?
```

The decade table shows the measured values for each plot at every point where the trace(s) cross(es) a decade line on the display. This command turns the decade table display on or off.

Example: CALC:LPL:DEC:TABL ON

Remarks: The LPLot keyword must be specified in the command.

Front Panel

Access: Meas Setup, More, Decade Table

Copy Trace A to Trace B

```
:CALCulate:LPLot:TRACe:COPIY[A] [B]
```

Copies the contents of one trace [A] to another trace [B].

Remarks: There are no spaces in the command. In other words, :COPY12 is a valid command that would copy Trace 1 and Trace 2. :COPY1 2 would be invalid as it contains a space.

Front Panel

Access: Trace/View, More, Operations

Trace Mode

```
:CALCulate:LPLot:TRACe[1] | 2 | 3:MODE RAW|SMOothed|VIEW|BLANK
```

```
:CALCulate:LPLot:TRACe[1] | 2 | 3:MODE?
```

This determines the type of trace stored and displayed in the selected trace.

Factory Preset: Trace 1: Raw

Trace 2: Smoothed

Trace 3: Blank

Range: Raw, Smoothed, View or Blank

Front Panel

Access: **Trace/View, Trace[1|2|3], Raw|Smoothed|View|Blank**

Swap Trace A and Trace B

:CALCulate:LPLot:TRACe:SWAP [A] [B]

Swaps the contents of two traces, [A] and [B]. Trace [A] data moves to Trace [B], while Trace [B] data moves to Trace [A].

Remarks: There are no spaces in the command. In other words, :SWAP12 is a valid command that would swap Trace 1 to Trace 2 data. :SWAP1 2 would be invalid as it contains a space.

Front Panel

Access: **Trace/View, More 1 of 2, Operations**

CALCulate:MARKers Subsystem

Marker Mode

:CALCulate:LPLot:MARKer [1] | 2 | 3 | 4:MODE POSition | DELTa | RMSDegree | RMSRadian | RFM | RMSJitter | OFF

:CALCulate:LPLot:MARKer [1] | 2 | 3 | 4:MODE?

This command specifies the calculation mode for each of the four markers.

- POSition - Sets the specified marker to be a 'normal' marker. That is, it measures the phase noise at your specified frequency offset.
- DELTa - Sets the specified marker to measure the difference in frequency between the first and the second marker.
- RMSDegree - Sets the specified marker to measure the RMS of the phase noise between the first and the second marker. The result is displayed in degrees.
- RMSRadian - Sets the specified marker to measure the RMS of the phase noise between the first and the second marker. The result is displayed in radians.
- RFM - Sets the specified marker to measure the RMS of the residual

FM between the first and the second marker. The result is displayed in Hertz.

- RMSJitter - Sets the specified marker to measure the RMS of the jitter between the first and the second marker. The result is displayed in units of time.
- OFF - Turns the marker off.

Example: **CALC:LPL:MARK:MODE RMSD**

Remarks: The LPLot keyword must be specified in the command.

Front Panel

Access: **Marker**

Marker Table On/Off

:CALCulate:LPLot:MARKer:TABLE[:STATe] OFF|ON|0|1

:CALCulate:LPLot:MARKer:TABLE[:STATe] ?

Turns the marker table display on or off.

Example: **CALC:LPL:MARK:TABL ON**

Remarks: The LPLot keyword must be specified in the command.

Front Panel

Access: **Marker, More 1 of 2, Marker Table**

Marker Trace

:CALCulate:LPLot:MARKer[1]|2|3|4:TRACe <tracenum>

:CALCulate:LPLot:MARKer[1]|2|3|4:TRACe?

This command specifies the trace on which the specified marker will be placed.

Example: **CALC:LPL:MARK:TRAC 3**

Remarks: The LPLot keyword must be specified in the command.

Front Panel

Access: **Marker, Select Marker, Marker Trace**

Marker X Value

:CALCulate:LPLot:MARKer[1]|2|3|4:X <number>

:CALCulate:LPLot:MARKer[1]|2|3|4:X?

This command positions the selected marker at the specified position on

the X-axis.

Range: Graph Start Offset and Stop Offset frequencies.

Factory Preset: All four markers are preset to 10 kHz

Example: CALC:LPL:MARK:X 2.5 MHz

Front Panel

Access: **Marker**

Marker Y Value

:CALCulate:LPLot:MARKer [1] | 2 | 3 | 4 :Y?

This command queries and returns the current Y value for the selected marker. The value is returned in the Y-axis units of the current trace (typically dBc/Hz).

Range: -200.0 to 200.0 dBc/Hz, dB/Hz, Radians or Degrees, depending on the type of marker.

Example: CALC:LPL:MARK3:Y?

Front Panel

Access: **Marker**

CONFigure Subsystem

The CONFigure commands are used with several other commands to control the measurement process. The full set of commands are described in the section “MEASure Group of Commands” on page 111.

Selecting measurements with the CONFigure/FETCh/MEASure/READ commands sets the instrument state to the defaults for that measurement and to make a single measurement. Other commands are available for each measurement to allow you to change: settings, view, limits, and so forth. Refer to:

SENSE:<measurement>, SENSE:CHANnel, SENSE:CORRection,
SENSE:DEFaults, SENSE:DEVIation, SENSE:FREQuency,
SENSE:PACKet, SENSE:POWer, SENSE:RADio, SENSE:SYNC
CALCulate:<measurement>, CALCulate:CLIMits
DISPlay:<measurement>
TRIGger

The INITiate[:IMMediate] or INITiate:REStart commands will initiate the taking of measurement data without resetting any of the measurement settings that you have changed from their defaults.

Configure the Selected Measurement

:CONFigure:<measurement>

A CONFigure command must specify the desired measurement (LPLot, MONitor, or SFRequency). It will set the instrument settings for that measurement's standard defaults, but should not initiate the taking of data. The available measurements are described in the MEASure subsystem.

NOTE

If CONFigure initiates the taking of data, the data should be ignored. Other SCPI commands can be processed immediately after sending CONFigure. You do not need to wait for the CONF command to complete this 'false' data acquisition.

Configure Query

:CONFigure?

The CONFigure query returns the name of the current measurement.

DISPlay Subsystem

The DISPlay commands control the selection and presentation of textual, graphical, and TRACe information. Within a DISPlay command, information may be separated into individual WINDows.

Set the Display Line

```
:DISPlay:MONitor:WINDow:TRACe:Y:DLINe <ampl>
```

```
:DISPlay:MONitor:WINDow:TRACe:Y:DLINe?
```

Defines the level of the display line, in the active amplitude units if no units are specified.

Factory Preset: -25 dBm

Range: 10 display divisions below the reference level to the reference level

Default Unit: Current active units

Front Panel

Access: **Display, Display Line**

Control the Display Line

```
:DISPlay:MONitor:WINDow:TRACe:Y:DLINe:STATe OFF|ON|0|1
```

```
:DISPlay:MONitor:WINDow:TRACe:Y:DLINe:STATe?
```

Turns the display line on or off.

Factory Preset: Off

Front Panel

Access: **Display, Display Line**

Set the Display Reference Level

```
:DISPlay:MONitor:WINDow:TRACe:Y:RLEVel
```

```
:DISPlay:MONitor:WINDow:TRACe:Y:RLEVel?
```

Allows the reference level to be changed. The reference level is the amplitude (power or voltage) represented by the top graticule on the display. Changing the reference level changes the absolute amplitude level (in the selected amplitude units) of the top graticule line.

Factory Preset: 10 dBm (automatically adjusted, depending on power)

Range: – 170 to 30 dBm in 1 dB steps

Front Panel

Access: **AMPLITUDE/YScale, Ref Level**

Set the Display Amplitude Scale

`:DISPlay:MONitor:WINDow:TRACe:Y[:SCALE]:PDIVision`

`:DISPlay:MONitor:WINDow:TRACe:Y[:SCALE]:PDIVision?`

Allows you to specify the amplitude scale per division.

Factory Preset: 10 dB

Range: 0.1 to 20 dB

Front Panel

Access: **AMPLITUDE/YScale, Scale/Div**

FETCh Subsystem

The FETCh? queries are used with several other commands to control the measurement process. These commands are described in the section on the “[MEASure Group of Commands](#)” on [page 111](#). These commands apply only to measurements found in the MEASURE menu.

This command puts selected data from the most recent measurement into the output buffer (new data is initiated/measured). Use FETCh if you have already made a good measurement and you want to look at several types of data (different [n] values) from the single measurement. FETCh saves you the time of re-making the measurement. You can only fetch results from the measurement that is currently active.

If you need to make a new measurement, use the READ command, which is equivalent to an INITiate[:IMMEDIATE] followed by a FETCh.

:FETCh <meas>? will return valid data only when the measurement is in one of the following states:

- idle
- initiated
- paused

Fetch the Current Measurement Results

:FETCh:<measurement> [n] ?

A FETCh? command must specify the desired measurement. It will return the valid results that are currently available, but will not initiate the taking of any new data. You can only fetch results from the measurement that is currently selected. The code number n selects the kind of results that will be returned. The available measurements and data results are described in the “[MEASure Group of Commands](#)” on [page 111](#).

FORMat Subsystem

The FORMat subsystem sets a data format for transferring numeric and array information.

Measurement Results format

:FORMat:MEASure[:DATA] ASCi|REAL32

:FORMat:MEASure[:DATA]?

This command controls the format of measurement data that is transferred to a remote user. The REAL and ASCII formats will format trace data in the current amplitude units.

ASCII - Values are in ASCII, in amplitude units, separated by commas. ASCII format requires more memory than the binary formats. Therefore, handling large amounts of this type of data, will take more time and storage space.

Real32 - Binary 32-bit real values in amplitude units, in a definite length block. Transfers of real data are done in a binary block format.

A definite length block of data starts with an ASCII header that begins with # and indicates how many additional data points are following in the block. Suppose the header is #512320.

- The first digit in the header (5) tells you how many additional digits/bytes there are in the header.
- The 12320 means 12 thousand, 3 hundred, 20 data bytes follow the header.
- Divide this number of bytes by your selected data format bytes/point, that is divide by 4 for real32. In this example, if you are using real32 then there are 3080 points in the block.

Factory Preset: ASCII

Front Panel Access: Not Applicable. This is a remote command only.

INITiate Subsystem

The INITiate subsystem is used to start a trigger for a measurement. These commands only initiate measurements from the MEASURE front-panel key or the “MEASure Group of Commands” on page 111. Refer also to the TRIGger and ABORt subsystems for related commands.

Take New Data Acquisition for Selected Measurement

:INITiate:<measurement>

This command initiates a trigger cycle for the measurement specified, but does not return data. The valid measurement names are described in the MEASure subsystem.

If your selected measurement is not currently active, the instrument will change to the measurement in your INIT:<meas> command and initiate a trigger/measurement cycle.

This command is now available for the one-button measurements in the Spectrum Analysis mode. Added with firmware revision A.10.00.

Example: INIT:ACP

INSTRUMENT Subsystem

This subsystem includes commands for querying and selecting instrument measurement (personality option) modes.

Catalog Query

:INSTRUMENT:CATALOG?

Returns a comma separated list of strings which contains the names of all the installed applications. These names can only be used with the **INST:SELECT** command.

Example: INST:CAT?

Query response: "CDMA"4,"PNOISE"14

Select Application by Number

:INSTRUMENT:NSELECT <integer>

:INSTRUMENT:NSELECT?

Select the measurement mode by its instrument number. The actual available choices depends upon which applications are installed in the instrument.

- 1 = SA (PSA)
- 4 = CDMA (cdmaOne) (E4406/PSA)
- 5 = NADC (E4406/PSA)
- 6 = PDC (E4406/PSA)
- 8 = BASIC (E4406/PSA)
- 9 = WCDMA (W-CDMA with HSDPA/HSUPA) (E4406/PSA)
- 10 = CDMA2K (cdma2000 with 1xEV-DV) (E4406/PSA)
- 13 = EDGE GSM (E4406/PSA)
- 14 = PNOISE (phase noise) (PSA)
- 15 = CMDA1XEV (1xEV-D0) (E4406/PSA)
- 18 = WLAN (PSA)
- 211 = TDSCDMA (PSA)
- 212 = TDDEMOD (PSA)
- 219 = NFIGURE (noise figure) (PSA)
- 233 = MRECEIVE (PSA)
- 239 = EMC (EMC Analyzer) (PSA)
- 241 = DMODULATION (PSA)

NOTE

If you are using the SCPI status registers and the analyzer mode is changed, the status bits should be read, and any errors resolved, prior to switching modes. Error conditions that exist prior to switching modes cannot be detected using the condition registers after the mode change. This is true unless they recur after the mode change, although transitions of these conditions can be detected using the event registers.

Changing modes resets all SCPI status registers and mask registers to their power-on defaults. Hence, any event or condition register masks must be re-established after a mode change. Also note that the power up status bit is set by any mode change, since that is the default state after power up.

Example: INST:NSEL 4

Factory Preset: Persistent state with factory default of 1

Range: 1 to x, where x depends upon which applications are installed.

Front Panel

Access: **MODE**

Select Application

:INSTrument [:SElect]

**SA | PNOISE | BASIC | CDMA | CDMA2K | EDGE GSM | NADC
 | PDC | WCDMA | CDMA1XEV | NFIGURE | WLAN | MRECEIVE
 | TDSCDMA | TDDEMOD | EMC | DEMODULATION**

:INSTrument [:SElect] ?

Select the measurement mode. The actual available choices depend upon which modes (measurement applications) are installed in the instrument. A list of the valid choices is returned with the INST:CAT? query.

Once an instrument mode is selected, only the commands that are valid for that mode can be executed.

- 1 = SA (PSA)
- 4 = CDMA (cdmaOne) (E4406/PSA)
- 5 = NADC (E4406/PSA)
- 6 = PDC (E4406/PSA)
- 8 = BASIC (E4406/PSA)
- 9 = WCDMA (W-CDMA with HSDPA/HSUPA) (E4406/PSA)
- 10 = CDMA2K (cdma2000 with 1xEV-DV) (E4406/PSA)
- 13 = EDGE GSM (E4406/PSA)
- 14 = PNOISE (phase noise) (PSA)
- 15 = CMDA1XEV (1xEV-D0) (E4406/PSA)
- 18 = WLAN (PSA)
- 211 = TDSCDMA (PSA)
- 212 = TDDEMOD (PSA)
- 219 = NFIGURE (noise figure) (PSA)
- 233 = MRECEIVE (PSA)
- 239 = EMC (EMC Analyzer) (PSA)
- 241 = DMODULATION (PSA)

NOTE

If you are using the status bits and the analyzer mode is changed, the status bits should be read, and any errors resolved, prior to switching modes. Error conditions that exist prior to switching modes cannot be detected using the condition registers after the mode change. This is true unless they recur after the mode change, although transitions of these conditions can be detected using the event registers.

Changing modes resets all SCPI status registers and mask registers to their power-on defaults. Hence, any event or condition register masks must be re-established after a mode change. Also note that the power up status bit is set by any mode change, since that is the default state after power up.

Example: INST:SEL CDMA

Factory Preset: Persistent state with factory default of Spectrum Analyzer mode

Front Panel

Access: **MODE**

MEASure Group of Commands

This group includes the CONFigure, FETCh, MEASure, and READ commands that are used to make measurements and return results. The different commands can be used to provide fine control of the overall measurement process, like changing measurement parameters from their default settings. Most measurements should be done in single measurement mode, rather than measuring continuously.

The SCPI default for the format of any data output is ASCII. The format can be changed to binary with FORMat:MEASure:DATA which transports faster over the bus.

CONFigure, FETCh, MEASure, READ Interactions

These commands are all inter-related. See [Figure 5-1 on page 112](#).

Measure Commands

:MEASure:<measurement> [n] ?

This is a fast single-command way to make a measurement using the factory default instrument settings. These are the settings and units that conform to the Mode Setup settings (for example, radio standard) that you have currently selected.

- Stops the current measurement (if any) and sets up the instrument for the specified measurement using the factory defaults.
- Initiates the data acquisition for the measurement.
- Blocks other SCPI communication, waiting until the measurement is complete before returning results.
- After the data is valid it returns the scalar results, or the trace data, for the specified measurement. The type of data returned may be defined by an [n] value that is sent with the command.

The scalar measurement results will be returned if the optional [n] value is not included, or is set to 1. If the [n] value is set to a value other than 1, the selected trace data results will be returned. See each command for details of what types of scalar results or trace data results are available.

ASCII is the default format for the data output. The binary data formats should be used for handling large blocks of data since they are smaller and faster than the ASCII format. Refer to the FORMat:DATA command for more information.

If you need to change some of the measurement parameters from the factory default settings, you can set up the measurement with the CONFigure command. Use the commands in the

SENSE:<measurement> and CALCulate:<measurement> subsystems to change the settings. Then you can use the READ? command to initiate the measurement and query the results. See Figure 5-1.

If you need to repeatedly make a given measurement with settings other than the factory defaults, you can use the commands in the SENSE:<measurement> and CALCulate:<measurement> subsystems to set up the measurement. Then use the READ? command to initiate the measurement and query results.

Measurement settings persist if you initiate a different measurement and then return to a previous one. Use READ:<measurement>? if you want to use those persistent settings. If you want to go back to the default settings, use MEASure:<measurement>?.

Figure 5-1 Measurement Group of Commands

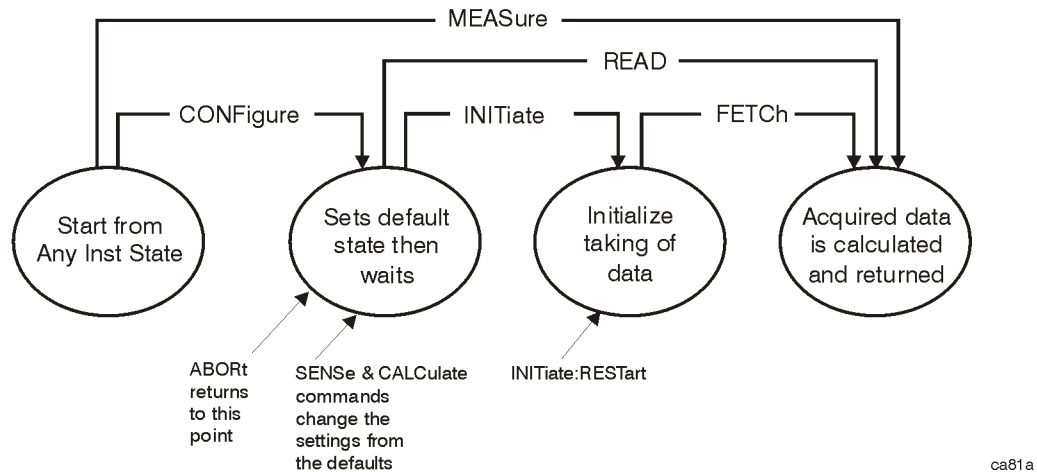

Configure Commands

:CONFigure:<measurement>

This command stops the current measurement (if any) and sets up the instrument for the specified measurement using the factory default instrument settings. It sets the instrument to single measurement mode but should not initiate the taking of measurement data unless INIT:CONTinuous is ON. After you change any measurement settings, the READ command can be used to initiate a measurement without changing the settings back to their defaults.

The CONFigure? query returns the current measurement name.

Fetch Commands

:FETCh: <measurement> [n] ?

This command puts selected data from the most recent measurement into the output buffer. Use FETCh if you have already made a good measurement and you want to return several types of data (different [n] values; for example, both scalars and trace data) from a single measurement. FETCh saves you the time of re-making the measurement. You can only FETCh results from the measurement that is currently active, it will not change to a different measurement.

If you need to get new measurement data, use the READ command, which is equivalent to an INITiate followed by a FETCh.

The scalar measurement results will be returned if the optional [n] value is not included, or is set to 1. If the [n] value is set to a value other than 1, the selected trace data results will be returned. See each command for details of what types of scalar results or trace data results are available. The binary data formats should be used for handling large blocks of data since they are smaller and transfer faster than the ASCII format. (FORMat:DATA)

FETCh may be used to return results other than those specified with the original READ or MEASure command that you sent.

Read Commands

:READ:<measurement> [n] ?

- Does not preset the measurement to the factory default settings. For example, if you have previously initiated the ACP measurement and you send READ:ACP? it will initiate a new measurement using the same instrument settings.
- Initiates the measurement and puts valid data into the output buffer. If a measurement other than the current one is specified, the instrument will switch to that measurement before it initiates the measurement and returns results.

For example, suppose you have previously initiated the ACP measurement, but now you are running the channel power measurement. Then you send READ:ACP? It will change from channel power back to ACP and, using the previous ACP settings, will initiate the measurement and return results.

- Blocks other SCPI communication, waiting until the measurement is complete before returning the results.

If the optional [n] value is not included, or is set to 1, the scalar measurement results will be returned. If the [n] value is set to a value other than 1, the selected trace data results will be returned. See each command for details of what types of scalar results or trace data results are available. The binary data formats should be used when handling large blocks of data since they are smaller and faster than the ASCII format. (FORMat:DATA)

Phase Noise Log Plot Measurement

This measures the phase noise of a signal at a specified frequency range offset from the main carrier signal. The results are plotted on a graph of phase noise power against the log of the offset frequency. You must be in the Phase Noise mode to use this command. Use INSTRument:SElect to set the mode.

The general functionality of CONFigure, FETCh, MEASure, and READ are described at the beginning of this section. See the SENSE:LPLot commands for more measurement related commands.

:FETCh:LPLot [n] ?

:READ:LPLot [n] ?

:MEASure:LPLot [n] ?

Front Panel

Access: **Measure, Log Plot**

After the measurement is selected, press **Restore Meas Defaults** to restore factory defaults.

Measurement Results Available

n	Results Returned
0	No return value.
not specified or n=1	Returns seven comma-separated scalar values corresponding to the following measurement results: <ol style="list-style-type: none"> 1. Carrier Power (dBm) 2. Carrier Frequency (Hz) 3. RMS Phase Noise over the entire smoothed trace (degrees) 4. RMS Phase Noise over the entire smoothed trace (radians) 5. Residual FM over the entire smoothed trace (Hz) 6. Spot Noise at the Start Offset Frequency (dBc/Hz) 7. Spot Noise at the Stop Offset Frequency (dBc/Hz)
n=2	Returns three comma-separated scalar values corresponding to the following measurement values: <ol style="list-style-type: none"> 1. Number of x/y value pairs in Trace 1 2. Number of x/y value pairs in Trace 2 3. Number of x/y value pairs in Trace 3

n	Results Returned
n=3	Returns a comma-separated list of the data points from Trace 1. The number of data points in the trace depends on the implementation and the frequency range being measured. This can be found by using the :LLOT2? command (above):
n=4	Returns a comma-separated list of the data points from Trace 2. The number of data points in the trace depends on the implementation and the frequency range being measured. This can be found by using the :LLOT2? command (above):
n=5	Returns a comma-separated list of the data points from Trace 3. The number of data points in the trace depends on the implementation and the frequency range being measured. This can be found by using the :LLOT3? command (above):
n=6	Returns a comma-separated list of the data points which represent the values found on each trace at each decade offset frequency. The points in the list are returned in the following order: Frequency Offset, Trace number 1 (yellow) amplitude, Trace number 2 (cyan blue) amplitude and Trace number 3 (magenta pink) amplitude. Any data points that do not have an associated trace, or any data points not covered by a particular frequency will return SCPI_NAN. The total number of values listed can be calculated by multiplying the number of decades by 4, and adding 4.

Monitor Spectrum

This measures the power levels across the specified spectral band using one of three traces. By default, the analyzer's entire range is measured.

The general functionality of **CONFigure**, **FETCh**, **MEASure**, and **READ** are described at the beginning of this section. See the **SENSe:MONitor** commands for more measurement related commands.

:CONFigure:MONitor

:FETCh:MONitor [n]

:READ:MONitor [n]

:MEASure:MONitor [n]

Front Panel

Access: **Measure, Monitor Band/Channel**

After the measurement is selected, press
Restore Meas Defaults to restore factory defaults.

Measurement Results Available

n	Results Returned
not specified or n=1	Trace 1 data
2	Trace 2 data
3	Trace 3 data

Phase Noise Spot Frequency Measurement

This measures the phase noise of a signal at a specified frequency offset from the main carrier signal. You must be in the Phase Noise mode to use this command. Use `INSTRument:SElect` to set the mode.

The general functionality of `CONFigure`, `FETCh`, `MEASure`, and `READ` are described at the beginning of this section. See the `SENSe:SFrequency` commands for more measurement related commands.

`:FETCh:SFrequency [n] ?`

`:READ:SFrequency [n] ?`

`:MEASure:SFrequency [n] ?`

Front Panel

Access: **Measure, Spot Frequency**

After the measurement is selected, press **Restore Meas Defaults** to restore factory defaults.

Measurement Results Available

n	Results Returned
0	No return value.
not specified or n=1	Returns six comma-separated scalar values corresponding to the following measurement results: <ol style="list-style-type: none"> 1. Carrier Power (dBm) 2. Carrier Frequency (Hz) 3. Initial carrier frequency (Hz) 4. Carrier frequency delta (Hz) 5. Upper or right SSB (Single Side Band) noise (dBc/Hz) 6. Average SSB (Single Side Band) noise (dBc/Hz)
n=2	Returns 101 comma-separated scalar values representing a trail of the measured phase noise of the carrier signal.
n=3	Returns 101 comma-separated scalar values representing a trail of the measured carrier frequencies.
n=4	Returns 101 comma-separated scalar values representing a trail of the measured carrier powers.

MMEMory Subsystem

The purpose of the MMEMory subsystem is to provide access to mass storage devices such as internal or external disk drives. If mass storage is not specified in the filename, the default mass storage specified in the MSIS command will be used.

The analyzer uses two types of mass storage devices:

- 3.5 inch disk drive (high density, 1.44 MBytes formatted) designated “A:”
- Part of flash memory and treated as a device designated “C:”

The MMEMory command syntax term <file_name> is a specifier having the form: drive:name.ext, where the following rules apply:

- “drive” is “A:” or “C:”
- “name” is a DOS file name of up to eight characters, letters (A-Z, a-z) and numbers (0-9) only (lower case letters are read as uppercase)
- “ext” is an optional file extension using the same rules as “name,” but consists of up to three characters total. (The default file extension will be added if it is not specified.)

Load a Log Plot Reference Trace from Disk

```
:MMEMory:LPLot:LOAD:TRACe <tracenum>,<filename>
```

```
:MMEMory:LPLot:LOAD:TRACe <tracenum>,<filename>
```

Loads the contents of a data file to one of the traces. You must specify the complete file name and path, for example A:\mytrace.lpt.

Example: :MMEM:LPL:LOAD:TRAC 2,“C:MYTRACE.lpt”

Remarks: See also the command
MMEMory:LPLot:STORe:TRACe<tracenum>,<filename>
e>

Front Panel

Access: **Trace/View, More 1 of 2, Load/Save, Drive**

Trace/View, More 1 of 2, Load/Save, Filename

Trace/View, More 1 of 2, Load/Save, Load Trace

Remarks: Three separate actions have to be performed when using the front-panel keys to save a file. First the drive has to be specified. Then the file name has to be specified. Finally you have to use the **Load Trace** softkey to load the data to your specified trace.

The two options when specifying the drive are A: (a standard floppy disk) or C: (the analyzer's internal memory).

Store a Log Plot Reference Trace to Disk

`:MMEMory:LPLot:STORe:TRACe <tracenum>,<filename>`

`:MMEMory:LPLot:STORe:TRACe <tracenum>,<filename>`

Stores the contents of one of the traces to disk or to the analyzer's own internal file system for loading at a later time. You must specify the complete file name and path, for example A:\mytrace.lpt.

Example: `:MMEM:LPL:STOR:TRAC 2,"C:MYTRACE.LPT"`

Remarks: See also the command
`:MMEMory:LPLot:LOAD:TRACe<tracenum>,<filename>`

Front Panel

Access: **Trace/View, More 1 of 2, Load/Save, Drive**

Trace/View, More 1 of 2, Load/Save, Filename

Trace/View, More 1 of 2, Load/Save, Save Trace

Remarks: Three separate actions have to be performed when using the front panel keys to save a file. First the volume has to be specified. Then the file name has to be specified. Finally you have to use the **Save Trace** softkey to save the data to your specified file.

The two options when specifying the volume are A: (a standard floppy disk) or C: (the instrument's internal memory).

READ Subsystem

The READ? commands are used with several other commands and are documented in the section on the “[MEASure Group of Commands](#)” on [page 111](#).

Initiate and Read Measurement Data

:READ:<measurement> [n] ?

A READ? query must specify the desired measurement. It will cause a measurement to occur without changing any of the current settings and will return any valid results. The code number n selects the kind of results that will be returned. The available measurements and data results are described in the “[MEASure Group of Commands](#)” on [page 111](#).

SENSe Subsystem

These commands are used to set the analyzer state parameters so that you can measure a particular input signal. Some SENSe commands are only for use with specific measurements found under the MEASURE key menu or the “MEASure Group of Commands” on page 111. The measurement must be active before you can use these commands.

The SCPI default for the format of any data output is ASCII. The format can be changed to binary with FORMat:DATA which transports faster over the bus.

Display Average Noise Level—Measurement Method

```
[[:SENSe]:DANL:METhod ATTenuator|REMOval
```

```
[[:SENSe]:DANL:METhod?
```

Specifies which of the two possible methods of measuring DANL is to be used. Setting the Mode to Attenuator causes the analyzer to attenuate any input signal to such a degree that it disappears into the background noise. The noise level can then be measured. Setting the Mode to Removal requires that the input cable be physically disconnected from the analyzer before the measurement is made.

Factory Preset: Attenuator

Remarks: Removal is the more accurate method of measuring DANL, but Attenuator is generally more convenient and is suitable for most purposes.

Front Panel

Access: **Input/Output, DANL Method**

Default Reset

```
[[:SENSe]:DEFaults
```

Restores personality Mode Setup defaults.

Front Panel

Access: **Mode Setup**

Remarks: This command sets all the SENSe defaults but has no effect on the MEASure default settings. Use the CONFigure:<measurement> command to set measurement defaults.

Frequency Commands

Carrier Frequency

`[:SENSe] :FREQuency :CARRier <freq>`

`[:SENSe] :FREQuency :CARRier?`

Specifies the frequency of the carrier.

Factory Preset: 50 MHz

Range: E4443A: 3 Hz to 6.78 GHz

E4445A: 3 Hz to 13.3 GHz

E4440A: 3 Hz to 27.0 GHz

100 Hz with Option UKB

Front Panel

Access: **FREQUENCY/Channel**

Carrier Search

`[:SENSe] :FREQuency :CARRier :SEARCh`

Automatically searches for and tunes to the strongest signal within the currently specified search span.

Front Panel

Access: **FREQUENCY/Channel**

Remarks: When Search Span is set to Auto, the analyzer searches the entire spectrum above 100 Hz. When Search Span is set to manual, the search is limited to the currently specified frequency span centered on the current carrier frequency.

Search Span Automatic

`[:SENSe] :FREQuency :CARRier :SEARCh :AUTO ON | OFF | 1 | 0`

`[:SENSe] :FREQuency :CARRier :SEARCh :AUTO?`

Specifies whether automatic setting of the frequency span is set to On or Off. When Search Auto is set to On, the analyzer searches the entire spectrum above 100 Hz. When Search Auto is set to Off, the search is limited to the currently specified frequency span centered on the current carrier frequency.

Factory Preset: On

Front Panel

Access: **FREQUENCY/Channel**

Search Span

```
[ :SENSe ] :FREQUency :CARRier :SEARch :SPAN <freq>
```

```
[ :SENSe ] :FREQUency :CARRier :SEARch :SPAN?
```

Specifies the frequency range within which the analyzer will search for a carrier signal.

Factory Preset: 10 kHz

Range: 100 Hz to 200 MHz

Remarks: This is only applicable when automatic search span ([:SENSe] :FREQUency :CARRier :SEARch :AUTO) is set to Off.

Front Panel

Access: **FREQUENCY/Channel**

Signal Tracking

```
[ :SENSe ] :FREQUency :CARRier :TRACk [ :STATe ] OFF | ON | 1 | 0
```

```
[ :SENSe ] :FREQUency :CARRier :TRACk [ :STATe ] ?
```

Specifies whether or not the analyzer tracks a slowly drifting signal. When signal tracking is Off, the analyzer measures at a fixed frequency. When signal tracking is On, the analyzer repeatedly measures the frequency of the carrier signal to check for any change that might have occurred, and retunes to the new frequency if necessary.

Factory Preset: Off

Remarks: The repeated realignment of the carrier signal when signal tracking is On causes measurements to take longer than when signal tracking is Off.

Front Panel

Access: **FREQUENCY/Channel**

Signal Tracking Drift Span

```
[ :SENSe ] :FREQUency :CARRier :TRACk :DSPan <value>
```

```
[ :SENSe ] :FREQUency :CARRier :TRACk :DSPan?
```

Specifies the span, as a percentage of the carrier frequency, within which the frequency drift will be measured. For example, if a drift span of 12% is specified, the signal will be tracked as long as it remains

within plus or minus 6% of the most recent frequency measurement.

Factory Preset: 10%

Range: 10% to 25%

Remarks: Only available when signal tracking is On and the Spot Frequency measurement is running.

Front Panel

Access: **FREQUENCY/Channel**

Signal Tracking Interval

```
[ :SENSe] :FREQuency:CARRier:TRACk:INTerval <value>
```

```
[ :SENSe] :FREQuency:CARRier:TRACk:INTerval?
```

Specifies how often the analyzer retunes to a drifting carrier signal. If signal tracking is On and Tracking Mode is set to Interval or to Both, this value specifies the number of individual phase noise measurements that will be made before the analyzer retunes to the carrier signal.

Factory Preset: 10

Range: 1 to 100

Remarks: Only available when signal tracking is On, the Spot Frequency measurement is running, and Tracking Mode is set to Interval or to Both.

Front Panel

Access: **FREQUENCY/Channel**

Signal Tracking Mode

```
[ :SENSe] :FREQuency:CARRier:TRACk:METHod  
INTerval | TOLerance | BOTH
```

```
[ :SENSe] :FREQuency:CARRier:TRACk:METHod?
```

Specifies how signal tracking operates. When Tracking Method is set to Interval, the carrier frequency is checked every INTERVAL number of measurements. When Tracking Method is set to Tolerance, the carrier frequency is checked whenever the most recent phase error measurement deviates from the average measurement by TOLERANCE dBc/Hz. The two modes can be combined by specifying BOTH. In this case, retuning occurs either when INTERVAL measurements have been made or when a measurement deviates from the average by TOLERANCE dBc/Hz, depending on which happens first.

Factory Preset: Tolerance

Range: Interval | Tolerance | Both
Remarks: Only available when signal tracking is On and the Spot Frequency measurement is running.

Front Panel
Access: **FREQUENCY/Channel, Tracking**

Signal Tracking Tolerance

`[:SENSe] :FREQUency :CARRier :TRACk :TOLerance <value>`

`[:SENSe] :FREQUency :CARRier :TRACk :TOLerance?`

Specifies when the analyzer retunes to a drifting carrier signal. If signal tracking is On and Tracking Mode is set to Tolerance or to Both, the analyzer retunes to the carrier signal every time a measurement is made that differs from the previous measurement by TOLERANCE dBc/Hz.

Factory Preset: 10 dBc/Hz

Range: 0 dBc/Hz to 40 dBc/Hz
Remarks: Only available when signal tracking is On, the Spot Frequency measurement is running and Tracking Mode is set to Tolerance or to Both.

Front Panel
Access: **FREQUENCY/Channel, Tracking**

Amplitude Commands

Optimize Reference Level

`[:SENSe] :MONitor :POWER [:RF] :RANGe :AUTo`

Automatically optimizes the reference level and the attenuation settings for the signal present at the analyzer's input.

Front Panel
Access: **AMPLITUDE/YScale, Optimize Ref Level**

Attenuator Setting

`[:SENSe] :MONitor :POWER [:RF] :ATTenuation`

`[:SENSe] :MONitor :POWER [:RF] :ATTenuation?`

Allows you to specify the input attenuation in 2 dB increments.

Factory Preset: 10 dB

Range: 0 to 70 dB

Remarks: The input attenuator is normally coupled with the reference level control. When **Attenuation** is set to **Man** (manual), you can change the input attenuation using the front-panel step keys, the RPG knob, or the numeric keys. When **Attenuation** is set to **Auto**, the input attenuator is coupled with the reference level control.

Front Panel

Access: **AMPLITUDE/YScale, Attenuation**

Attenuator Mode

```
[ :SENSe] :MONitor:POWer [:RF] :ATTenuation:AUTO
```

```
[ :SENSe] :MONitor:POWer [:RF] :ATTenuation:AUTO?
```

Allows you to specify the attenuation mode, auto or manual.

Factory Preset: Auto

Remarks: The input attenuator is normally coupled with the reference level control. When attenuator mode is set to manual, you can change the input attenuation using the front-panel step keys, the RPG knob, or the numeric keys. When attenuator mode is set to auto, the input attenuator is coupled with the reference level control.

Front Panel

Access: **AMPLITUDE/YScale, Attenuation**

Bandwidth Commands

Resolution Bandwidth Value

```
[ :SENSe] :MONitor:BANDwidth|BWIDth [:RESolution] ?
```

Queries the resolution bandwidth setting in Monitor Spectrum measurements only. The front-panel **Res BW** key is grayed out in Spot Frequency and Log Plot measurements.

Factory Preset: Automatically calculated

Range: RBW MIN_Limit to RBW MAX_Limit

Remarks: When **Res BW** is set to **Man** (manual), you can select the resolution bandwidth using the front-panel keys or the RPG knob. When **Res BW** is set to **Auto**, the resolution

bandwidth is automatically calculated and can be queried using this SCPI command.

Front Panel

Access: **BW/Avg, Res BW**

Resolution Bandwidth Mode

```
[ :SENSe ] :MONitor :BANDwidth | BWIDth [ :RESolution ] :AUTO?
```

Queries the resolution bandwidth mode in Monitor Spectrum measurements only. The front-panel **Res BW** key is grayed out in Spot Frequency and Log Plot measurements.

Factory Preset: Auto

Remarks: When **Res BW** is set to **Man** (manual), you can select the resolution bandwidth using the front-panel keys or the RPG knob. When **Res BW** is set to **Auto**, the resolution bandwidth is automatically calculated.

Front Panel

Access: **BW/Avg, Res BW**

Video Bandwidth Value

```
[ :SENSe ] :MONitor :BANDwidth | BWIDth :VIDeo?
```

Queries the video bandwidth setting in Monitor Spectrum measurements only. The front-panel **Video BW** key is grayed out in Spot Frequency and Log Plot measurements.

Factory Preset: Automatically calculated

Range: VBW MIN_Limit to VBW MAX_Limit

Remarks: When **Video BW** is set to **Man** (manual), you can select the video bandwidth using the front-panel keys or the RPG knob. When **Video BW** is set to **Auto**, the video bandwidth is automatically calculated and can be read back using this SCPI command.

Front Panel

Access: **BW/Avg, Video BW**

Video Bandwidth Mode

```
[ :SENSe ] :MONitor :BANDwidth | BWIDth :VIDeo :AUTO?
```

Queries the video bandwidth mode setting in Monitor Spectrum measurements only. The front-panel **Video BW** key is grayed out in Spot

Frequency and Log Plot measurements.

Factory Preset: Auto

Remarks: When **Video BW** is set to **Man** (manual), you can select the video bandwidth using the front-panel keys or the RPG knob. When **Video BW** is set to **Auto**, the video bandwidth is automatically calculated.

Front Panel

Access: **BW/Avg, Video BW**

VBW/RBW Ratio

```
[ :SENSE ] :MONitor: BANDwidth | BWIDth:VIDeo:RATio <value>
```

```
[ :SENSE ] :MONitor: BANDwidth | BWIDth:VIDeo:RATio?
```

Allows you to specify the video bandwidth to resolution bandwidth ratio.

Factory Preset: 1.0

Range: 0.001 to 10.0

Front Panel

Access: **BW/Avg, VBW/RBW**

Span/RBW Ratio

```
[ :SENSE ] :MONitor: FREQUency: SPAN: BANDwidth | BWIDth  
[ :RESolution ] :RATio <value>
```

```
[ :SENSE ] :MONitor: FREQUency: SPAN: BANDwidth | BWIDth  
[ :RESolution ] :RATio?
```

Allows you to specify the span to resolution bandwidth ratio.

Factory Preset: 106 (automatically calculated)

Range: 2 to 10,000

Front Panel

Access: **BW/Avg, Span/RBW**

Span/RBW Mode

```
[ :SENSE ] :MONitor: FREQUency: SPAN: BANDwidth | BWIDth  
[ :RESolution ] :RATio: AUTO ON | OFF | 1 | 0
```

```
[ :SENSE ] :MONitor: FREQUency: SPAN: BANDwidth | BWIDth  
[ :RESolution ] :RATio: AUTO?
```

Allows you to toggle between auto and manual mode.

Factory Preset: Auto

Remarks: When **ON**, this parameter will display “Auto” on the front panel. When **OFF**, this parameter will display “Man” on the front panel.

Front Panel

Access: **BW/Avg, Span/RBW**

Detector Commands

Detector Mode

```
[ :SENSe ] :MONitor:DETEctor [ :FUNction ]
```

```
[ :SENSe ] :MONitor:DETEctor [ :FUNction ] ?
```

Allows you to select the type of video detection used.

Factory Preset: Average

Front Panel

Access: **Det/Demod, Detector**

Phase Noise Log Plot Measurements

Commands for querying the log plot measurement results and for setting to the default values are found in the “[MEASure Group of Commands](#)” on page 111. The equivalent front-panel keys for the parameters described in the following commands are found under the **Meas Setup** key when the **Log Plot** measurement has been selected from the **MEASURE** key menu.

Log Plot Number of Averages

```
[ :SENSe ] :LPLot:AVERage:COUNT <integer>
```

```
[ :SENSe ] :LPLot:AVERage:COUNT?
```

Specifies the number of measurements made when calculating the average result.

Factory Preset: 10

Range: 1 to 1000

Remarks: You must be in the Phase Noise mode to use this command. Use **INSTRument:SElect** to set the mode.

Front Panel
Access: **Meas Setup**

Log Plot Average State

`[:SENSE] :LPLot:AVERAge: [:STATe] ON | OFF | 1 | 0`

`[:SENSe] :LPLot:AVERAge [:STATe] ?`

Switches averaging on or off.

Factory Preset: Off (front-panel preset)

On (:CONFIgure via SCPI)

Remarks: You must be in the Phase Noise mode to use this command. Use INSTRument:SElect to set the mode.

Front Panel
Access: **Meas Setup**

Log Plot Averaging Mode Termination Control

`[:SENSe] :LPLot:AVERAge:TCONtrol?`

Queries and returns the type of termination control used for the averaging function. This determines the averaging action after the specified number of acquisitions (average count) is reached.

REPeat - After reaching the average count, the averaging is reset and a new average is started.

Factory Preset: REPeat

Remarks: The Average Mode will always be set to Repeat.

Log Plot Resolution Bandwidth Value

`[:SENSE] :LPLot:BANDwidth | BWIDth [:RESolution] ?`

Queries and returns the resolution bandwidth.

Default Unit: Hz

Front Panel
Access: **BW/Avg, Res BW**

Log Plot Resolution Bandwidth Mode

`[:SENSe] :LPLot :BANDwidth | BWIDth [:RESolution] :AUTO?`

Queries and returns the resolution bandwidth mode, manual or auto.

Factory Preset: Auto

Front Panel

Access: **BW/Avg, Res BW**

Log Plot Video Bandwidth

`[:SENSe] :LPLot :BANDwidth | BWIDth :VIDeo?`

Queries the video bandwidth.

Default Unit: Hz

Front Panel

Access: **BW/Avg, Video BW**

Log Plot Video Bandwidth Mode

`[:SENSe] :LPLot :BANDwidth | BWIDth :VIDeo :AUTO?`

Queries the video bandwidth mode, manual or auto.

Factory Preset: Auto

Front Panel

Access: **BW/Avg, Video BW**

Log Plot Video to Resolution Bandwidth Ratio

`[:SENSe] :LPLot :BANDwidth | BWIDth :VIDeo :RATio <numeric>`

`[:SENSe] :LPLot :BANDwidth | BWIDth :VIDeo :RATio?`

Specifies the ratio of the video bandwidth to the resolution bandwidth.

Factory Preset: 1.0

Range: 0.001 to 10

Front Panel

Access: **BW/Avg, VBW/RBW**

DANL Cancellation Delta Threshold

`[:SENSe] :LPLot :CANCellation :DELTA <dB>`

```
[ :SENSe ] :LPLot :CANCellation :DELta?
```

You can specify a minimum difference that must exist between the DANL reference trace and the current measurement before any cancellation will be performed. This command allows you to specify that minimum value.

Range: 0.001 dB - 5 dB

Example: LPL:CANC:DELT 2

Remarks: The cancellation delta is applied on an individual point by point basis.

Front Panel

Access: **Meas Setup, More, Cancellation**

DANL Cancellation On/Off

```
[ :SENSe ] :LPLot :CANCellation [:STATe] OFF | ON | 0 | 1
```

```
[ :SENSe ] :LPLot :CANCellation [:STATe] ?
```

This allows you to switch the noise cancellation feature on or off. The cancellation feature allows a previously made measurement of the instrument's DANL noise floor to be automatically subtracted from the current measurement.

Example: LPL:CANC ON

Remarks: The DANL of the instrument must first be measured and stored in a reference trace before the cancellation feature can be used.

Front Panel

Access: **Meas Setup, More 1 of 2, Cancellation**

DANL Cancellation Reference Trace

```
[ :SENSe ] :LPLot :CANCellation :TRACe <tracenum>
```

```
[ :SENSe ] :LPLot :CANCellation :TRACe?
```

This allows you to change the trace that is used to store the DANL noise floor reference data for use in the DANL cancellation feature.

Range: 1 - 3

Example: LPL:CANC:TRAC 2

Remarks: This reference trace must be in View mode and must cover the same frequency range as that being measured.

Front Panel

Access: **Meas Setup, More, Cancellation**

Log Plot Type of Detection

```
[ :SENSe ] :LPLot:DETEctor [ :FUNction ] ?
```

Queries and returns the detection mode.

Front Panel

Access: **Det/Demod, Detector**

Log Plot Diagnostic of Y-axis Reference Level

```
[ :SENSe ] :LPLot:DIAG:GRAPh:Y:REFerence <level>
```

```
[ :SENSe ] :LPLot:DIAG:GRAPh:Y:REFerence?
```

Sets and queries the Y-axis reference level.

Note that diagnostic commands may be changed suddenly, without notification.

Default Unit: dBc/Hz

Example: LPL:DIAG:GRAP:Y:REF -50

Front Panel

Access: **Amplitude**

Log Plot Filtering

```
[ :SENSe ] :LPLot:FILTEring:NONE | LITTLe | MEDium | MAXimum
```

This sets the video bandwidth/resolution bandwidth to one of four predetermined values (1.0, 0.3, 0.1 and 0.03).

Factory Preset: None (VBW/RBW ratio = 1.000)

Remarks: You cannot query this command. To find out the current setting, query the VBW/RBW parameter. See [“Log Plot Video Bandwidth” on page 132](#).

Front Panel

Access: **Meas Setup, Filtering**

Log Plot Start Offset

```
[ :SENSe ] :LPLot:FREQuency:OFFSet:STARt <freq>
```

```
[ :SENSe ] :LPLot:FREQuency:OFFSet:STARt?
```

Specifies the frequency offset at which the measurement starts. The frequency is measured relative to the carrier signal, and refers only to the upper sideband.

Factory Preset: 100 Hz

Range: 3 Hz to 1 decade less than **Stop Offset**

Remarks: You must be in the Phase Noise mode to use this command. Use INSTRument:SElect to set the mode.

Front Panel

Access: **Span/X Scale**

Log Plot Stop Offset

```
[ :SENSe ] :LPLot:FREQuency:OFFSet:STOP <freq>
```

```
[ :SENSe ] :LPLot:FREQuency:OFFSet:STOP?
```

Specifies the frequency offset at which the measurement stops. The frequency is measured relative to the carrier signal, and refers only to the upper sideband.

Factory Preset: 1 MHz

Range: 1 decade greater than **Start Offset** to nine decades greater than **Start Offset** (but limited by analyzer's range).

Remarks: You must be in the Phase Noise mode to use this command. Use INSTRument:SElect to set the mode.

Front Panel

Access: **Span/X Scale**

Log Plot Span to Resolution Bandwidth Ratio

```
[ :SENSe ] :LPLot:FREQuency:SPAN:Bandwidth  
|BWIDth[:RESolution]:RATio <numeric>
```

```
[ :SENSe ] :LPLot:FREQuency:SPAN:Bandwidth  
|BWIDth[:RESolution]:RATio?
```

Specifies the ratio of the span to the resolution bandwidth.

Factory Preset: 106

Range: 2 to 1000

Front Panel

Access: **BW/Avg, Span/RBW**

Log Plot Span to Resolution Bandwidth Ratio Mode

```
[ :SENSe ] :LPLot:FREQuency:SPAN:BANDwidth  
|BWIDth[:RESolution]:RATio:AUTO ON|OFF|1|0
```

```
[ :SENSe ] :LPLot:FREQuency:SPAN:BANDwidth  
|BWIDth[:RESolution]:RATio:AUTO?
```

Specifies whether the ratio of the span to the resolution bandwidth is set automatically.

Factory Preset: Auto

Remarks: When set to On or 1, the front panel will display ‘Auto’.
 When set to Off or 0, the front panel will display ‘Man’.

Front Panel

Access: **BW/Avg, Span/RBW**

Log Plot Measurement Type

```
[ :SENSe ] :LPLot:METHod DANL|PN
```

```
[ :SENSe ] :LPLot:METHod?
```

Determines whether you are measuring the phase noise of a signal or the noise floor (DANL) of the analyzer. Measuring the phase noise of a signal is the default, and is the intended use of the measurement. However, it can be useful to measure the noise floor of the analyzer so that you can compensate for this in your measurement. See [“\[:SENSe\]:DANL:METHod ATTenuator|REMOval” on page 122](#) for more details on the two different types of noise floor measurement.

Factory Preset: PN

Remarks: When measuring the phase noise of a signal, some of the measured phase noise is due to thermal noise generated by the analyzer itself. By measuring the analyzer’s internal noise, it can be compensated for, thus giving more accurate results.

You must be in the Phase Noise mode to use this command. Use INSTRument:SElect to set the mode.

Front Panel

Access: **Meas Setup**

Log Plot Smooth Trace

```
[ :SENSe ] :LPLot:SMOoth <percentage>
```

```
[ :SENSe ] :LPLot:SMOoth?
```

Specifies the amount of smoothing that is done after the measurement has been completed. The smoothing function is a lot faster than filtering, but it can cause errors if the noise changes rapidly with respect to frequency for example when there are discrete signals present, such as harmonic spurs.

Factory Preset: 4%

Range: 0% to 16%

Remarks: Changing the Smooth Trace parameter forces the smooth trace to be recalculated. This forces all results to be recalculated. There is therefore no need to perform a full restart.

You must be in the Phase Noise mode to use this command. Use INSTRument:SElect to set the mode.

Front Panel

Access: **Meas Setup**

Monitor Band/Channel Measurement

Commands for querying the monitor band/channel measurement results and for setting to the default values are found in the [“MEASure Group of Commands” on page 111](#). The equivalent front-panel keys for the parameters described in the following commands, are found under the **Meas Setup** key, after the **Monitor Band/Channel** measurement has been selected from the **MEASURE** key menu.

Monitor Band/Channel—Average Count

```
[ :SENSE ] :MONitor:AVERage:COUNT <integer>
```

```
[ :SENSE ] :MONitor:AVERage:COUNT?
```

Set the number of data acquisitions that will be averaged. After the specified number of average counts, the averaging mode (terminal control) setting determines the averaging action.

Factory Preset: 10

Range: 1 to 1,000

Remarks: You must be in the Phase Noise mode to use this command. Use INSTRument:SElect to set the mode.

Front Panel

Access: **Meas Setup, Avg Number**

Monitor Band/Channel—Averaging State

```
[ :SENSe ] :MONitor :AVERage [ :STATe ] OFF | ON | 0 | 1
```

```
[ :SENSe ] :MONitor :AVERage [ :STATe ] ?
```

Turn averaging on or off.

Factory Preset: On for GSM

Off for cdmaOne and Phase Noise.

Remarks: You must be in the Phase Noise mode to use this command. Use INSTRument:SElect to set the mode.

Front Panel

Access: **Meas Setup, Avg Number**

Monitor Band/Channel—Averaging Termination Control

```
[ :SENSe ] :MONitor :AVERage :TCONtrol EXPonential | REPeat
```

```
[ :SENSe ] :MONitor :AVERage :TCONtrol ?
```

Select the type of termination control used for the averaging function. This determines the averaging action after the specified number of data acquisitions (average count) is reached.

Exponential - After the average count is reached, each successive data acquisition is exponentially weighted and combined with the existing average.

Repeat - After reaching the average count, the averaging is reset and a new average is started.

Factory Preset: Exponential

Remarks: You must be in the Phase Noise mode to use this command. Use INSTRument:SElect to set the mode.

Front Panel

Access: **Meas Setup, Avg Mode**

Monitor Band/Channel—Frequency Span

```
[ :SENSe ] :MONitor :FREQuency :SPAN <freq>
```

```
[ :SENSe ] :MONitor :FREQuency :SPAN ?
```

Set the frequency span. Setting the span to 0 Hz puts the analyzer into zero span.

Factory
Preset: E4443A: 6.78 GHz
E4445A: 13.3 GHz
E4440A: 27.0 GHz
Range: E4443A: 3 Hz to 6.78 GHz
E4445A: 3 Hz to 13.3 GHz
E4440A: 3 Hz to 27.0 GHz
Default Unit: Hz
Front Panel
Access: **SPAN/X Scale, Span**
or **SPAN/X Scale, Zero Span**

Monitor Band/Channel—Full Frequency Span

`[:SENSe] :MONitor :FREQuency :SPAN :FULL`

Set the frequency span to full scale.

Factory
Preset: E4443A: 6.78 GHz
E4445A: 13.3 GHz
E4440A: 27.0 GHz

Front Panel
Access: **SPAN/X Scale, Full Span**

Monitor Band/Channel—Zero Frequency Span

`[:SENSe] :MONitor :FREQuency :SPAN :ZERO`

Set the frequency span to zero.

Factory Preset: E4443A: 6.78 GHz
E4445A: 13.3 GHz
E4440A: 27.0 GHz

Front Panel
Access: **SPAN/X Scale, Zero Span**

Monitor Band/Channel—Trace Points

`[:SENSe] :MONitor :SWEep :POINTs ?`

Allows you to query the number of trace points.

Factory Preset: 601

Range: Always 601

Front Panel

Access: **Sweep**

Monitor Band/Channel—Sweep Time

`[:SENSe] :MONitor :SWEep :TIME <value>`

`[:SENSe] :MONitor :SWEep :TIME ?`

Specifies the sweep time of the measurement.

Factory Preset: 14.6 ms (automatically calculated)

Range: 1 ms to 6 ksecs

Front Panel

Access: **Sweep**

Monitor Band/Channel—Time Mode

`[:SENSe] :MONitor :SWEep :TIME :AUTO ON | OFF | 1 | 0`

`[:SENSe] :MONitor :SWEep :TIME :AUTO ?`

Specifies whether the sweep time is set automatically or manually.

Factory Preset: Auto

Remarks: If set to **AUTO**, the sweep time will be affected by the RBW setting.

Front Panel

Access: **Sweep**

RF Power Commands

RF Mixer Maximum Power

`[:SENSe] :POWER [:RF] :MIXer :RANGE [:UPPer] <power>`

`[:SENSe] :POWER [:RF] :MIXer :RANGE [:UPPer] ?`

Specifies the maximum power at the input mixer.

Factory Preset: 4 dBm

Range: -100 dBm to 10 dBm

Default Unit: dBm

Front Panel
Access: **Input/Output, Advanced, Max Mixer Lvl**

Spot Frequency Measurements

Commands for querying the spot frequency measurement results and for setting to the default values are found in the “[MEASure Group of Commands](#)” on page 111. The equivalent front-panel keys for the parameters described in the following commands, are found under the **Meas Setup** key, after the **Spot Frequency** measurement has been selected from the **MEASURE** key menu.

Spot Frequency Number of Averages

```
[ :SENSE ] :SFrequency:AVERage:COUNT <integer>
```

```
[ :SENSE ] :SFrequency:AVERage:COUNT?
```

Specifies the number of measurements made when calculating the average result.

Factory Preset: 10

Range: 1 to 1000

Remarks: You must be in the Phase Noise mode to use this command. Use INSTRument:SElect to set the mode.

Front Panel
Access: **Meas Setup**

Spot Frequency Average State

```
[ :SENSE ] :SFrequency:AVERage [ :STATe ] ON | OFF | 1 | 0
```

```
[ :SENSE ] :SFrequency:AVERage [ :STATe ] ?
```

Switches averaging On or Off.

Factory Preset: Off

Remarks: You must be in the Phase Noise mode to use this command. Use INSTRument:SElect to set the mode.

Front Panel
Access: **Meas Setup**

Spot Frequency Averaging Mode Termination Control

```
[[:SENSe]:SFrequency:AVERAge:TCONtrol EXPonential|REPeat  
[:SENSe]:SFrequency:AVERAge:TCONtrol?
```

Select the type of termination control used for the averaging function. This determines the averaging action after the specified number of acquisitions (average count) is reached.

Exponential - Each successive data acquisition after the average count is reached, is exponentially weighted and combined with the existing average.

Repeat - After reaching the average count, the averaging is reset and a new average is started.

Factory Preset: Exponential

Remarks: You must be in the Phase Noise mode to use this command. Use INSTRument:SElect to set the mode.

Front Panel

Access: **Meas Setup**

Spot Frequency Resolution Bandwidth

```
[[:SENSe]:SFrequency:BANDwidth|BWIDth[:RESolution]?
```

Queries and returns the resolution bandwidth.

Front Panel

Access: **BW/Avg, Res BW**

Spot Frequency Resolution Bandwidth Automatic

```
[[:SENSe]:SFrequency:BANDwidth|BWIDth[:RESolution]:AUTO?
```

Queries the resolution bandwidth mode. This is only available in the Monitor Spectrum measurement.

Front Panel

Access: **BW/Avg, Res BW**

Spot Frequency Video Bandwidth

```
[[:SENSe]:SFrequency:BANDwidth|BWIDth:VIDeo?
```

Queries the video bandwidth.

Front Panel

Access: **BW/Avg, Video BW**

Spot Frequency Video Bandwidth Automatic

`[:SENSe] :SFRequency :BANDwidth | BWIDth :VIDEo :AUTO?`

Queries the video bandwidth mode.

Remarks: This command is not available in Spot Frequency and Log Plot measurements, and the softkey is grayed out.

Front Panel

Access: **BW/Avg, Video BW**

Spot Frequency Video to Resolution Bandwidth Ratio

`[:SENSe] :SFRequency :BANDwidth | BWIDth :VIDEo :RATio <numeric>`

`[:SENSe] :SFRequency :BANDwidth | BWIDth :VIDEo :RATio?`

Specifies the ratio of the video bandwidth to the resolution bandwidth.

Factory Preset: 1.0

Range: 0.001 to 10

Front Panel

Access: **BW/Avg, VBW/RBW**

Spot Frequency Type of Detection

`[:SENSe] :SFRequency :DETector [:FUNCTion] ?`

Queries and returns the detection mode.

Factory Preset: Average

Front Panel

Access: **Det/Demod, Detector**

Spot Frequency Measurement Type

`[:SENSe] :SFRequency :METHod DANL | PN`

`[:SENSe] :SFRequency :METHod?`

Determines whether you are measuring the phase noise of a signal or the noise floor of the analyzer itself. The noise floor is referred to as DANL (displayed average noise level). Measuring the phase noise of a signal is the default, and is the intended use of the measurement. However, if your phase noise level is low, it can be useful to measure the noise floor of the analyzer so that you can compensate for this in your measurement. See [“\[:SENSe\]:DANL:METHod ATTenuator | REMoval” on page 122](#) for more details on the two different types of noise floor

measurement.

Factory Preset: Phase Noise

Remarks: You must be in the Phase Noise mode to use this command. Use INSTRument:SElect to set the mode.

Front Panel

Access: Meas Setup, Meas Type

Spot Frequency Phase Noise Optimization

```
[ :SENSe ] :SFrequency:PNOFrequency <freq>
```

```
[ :SENSe ] :SFrequency:PNOFrequency?
```

The spectrum analyzer has two different filters which it can use to measure the phase noise. One filter is better suited to phase noise at small offsets, and the other is better suited to larger offsets. Use this command to specify the cross-over point from one filter to the other.

Factory Preset: 45 kHz

Range: 40 kHz to 60 kHz

Remarks: If you are measuring phase noise at a frequency offset between 40 kHz and 60 kHz, you can make one measurement with :PNOFrequency greater than your measurement's offset and one with :PNOFrequency smaller. The lower of the two phase noise figures is the more accurate.

You must be in the Phase Noise mode to use this command. Use INSTRument:SElect to set the mode.

Front Panel

Access: Meas Setup, Advanced, PhNoise opt f

Spot Frequency Phase Noise Optimization Mode

```
[ :SENSe ] :SFrequency:PNOFrequency:AUTO ON|OFF|1|0
```

```
[ :SENSe ] :SFrequency:PNOFrequency:AUTO?
```

The spectrum analyzer has two different filters which it can use to measure the phase noise. One filter is better suited to phase noise at small offsets, and the other is better suited to larger offsets. This command specifies whether the crossover point from one filter to the other is controlled automatically or is under manual control.

Factory Preset: On

Remarks: You must be in the Phase Noise mode to use this

command. Use INSTRument:SElect to set the mode.

Front Panel

Access: **Meas Setup, Advanced, PhNoise opt f**

Spot Frequency Offset

`[:SENSE] :SFrequency :SOFFset <value>`

`[:SENSe] :SFrequency :SOFFset?`

Specifies the frequency offset at which the phase noise is to be measured.

Factory Preset: 10 kHz

Range: 3 Hz to 100 MHz

Remarks: You must be in the Phase Noise mode to use this command. Use INSTRument:SElect to set the mode.

Front Panel

Access: **FREQUENCY/Channel, Tracking, Tolerance**

Resolution Bandwidth/Spot Frequency Offset Percent

`[:SENSe] :SFrequency :SOFFset :BANDwidth | BWIDth [:RESolution] :RATio <value>`

`[:SENSe] :SFrequency :SOFFset :BANDwidth | BWIDth [:RESolution] :RATio?`

The Resolution Bandwidth is specified as a percentage of the offset frequency. This command allows you to specify this percentage value.

Factory Preset: 10

Range: 1 to 30

Remarks: You must be in the Phase Noise mode to use this command. Use INSTRument:SElect to set the mode.

Front Panel

Access: **Meas Setup, more, Advanced, RBW/Spot Offset %**

Spot Frequency Sweep Time

`[:SENSe] :SFrequency :SWEep :TIME <value>`

`[:SENSe] :SFrequency :SWEep :TIME?`

Specifies the sweep time of the measurement.

Factory Preset: 5 ms

Range: 1 ms to 1 s
Remarks: You must be in the Phase Noise mode to use this command. Use INSTRument:SElect to set the mode.

Front Panel
Access: **Sweep**

Spot Frequency Sweep Time Mode

[:SENSe] :SFrequency :SWEep :TIME :AUTO ON | OFF | 1 | 0

[:SENSe] :SFrequency :SWEep :TIME :AUTO?

Specifies whether the sweep time is set automatically or manually.

Factory Preset: Auto

Remarks: You must be in the Phase Noise mode to use this command. Use INSTRument:SElect to set the mode.

Front Panel
Access: **Sweep**

6**Phase Noise Measurement
Concepts**

Introduction

This chapter includes the following topics:

[“What is Phase Noise?” on page 6-149](#)

- Definition
- Thermal Noise
- Other Noise Contributions
- AM Noise
- Residual FM
- Single-Sideband Noise

[“Phase Noise Measurements” on page 6-157](#)

- Log Plot Measurements
- Spot Frequency Measurements

[“Improving Phase Noise Measurements” on page 6-158](#)

- Smoothing, Averaging, and Filtering
- Signal Tracking
- Slowly Drifting Signals
- System Noise Floor
- Advanced Features - AM Rejection and Overdrive

What is Phase Noise?

Phase Noise is the term used to describe the aggregate noise power of unwanted modulation products close to a signal, at a specific offset from the actual carrier frequency. As this power is higher near the carrier but can extend far into the sidebands, the usual offsets are multiples of ten to allow logarithmic scale plots of the power levels. Noise power contributions may be due to several various mechanisms, and each will affect the carrier at different offsets. Among these are thermal noise, flicker noise, and white noise.

Before we get to the formal definitions of phase noise, let's look at the difference between an ideal signal (a perfect oscillator) and a real-world signal. In the frequency domain, the ideal signal is represented by a single spectral line (Figure 6-1).

In the frequency domain, the real world signal is no longer a single discrete spectral line. It is now represented by a spread of spectral lines, both above and below the nominal signal frequency, in the form of modulation sidebands. This is due to random amplitude and phase fluctuations.

There are always small, unwanted amplitude and phase fluctuations present on a signal. Notice that frequency fluctuations are actually an added term to the phase angle portion of the time domain equation. Because phase and frequency are related, you can discuss equivalently unwanted frequency or phase fluctuations.

Figure 6-1

Ideal RF Signal versus Real-World Signal

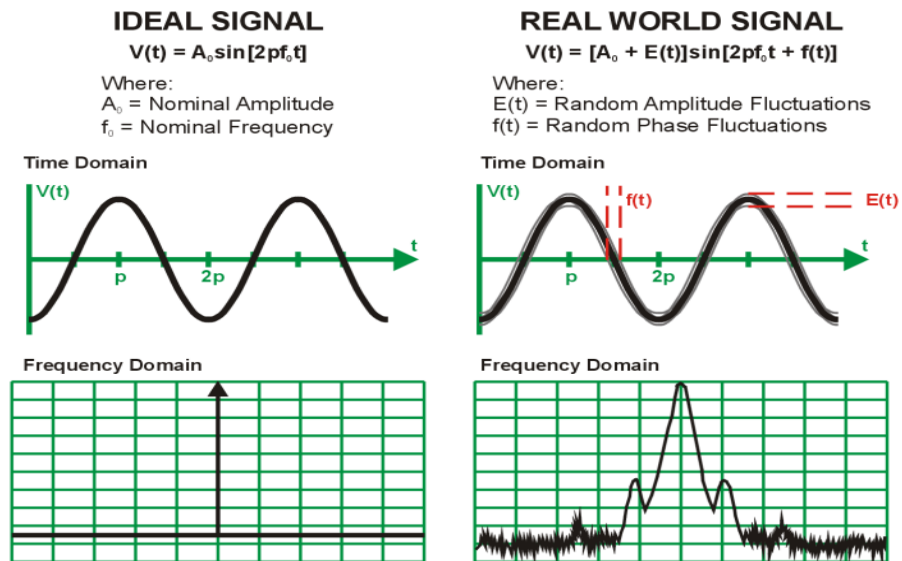

Historically, the most widely used phase noise unit of measure has been total single sideband power within a one hertz bandwidth at a frequency f away from the carrier referenced to the carrier frequency power. This unit of measure is represented as a $\mathcal{L}(f)$ in units of dBc/Hz (Figure 6-2).

Figure 6-2 Phase Noise Unit of Measure

$\mathcal{L}(f)$ is defined as single sideband power due to phase fluctuations referenced to the carrier frequency power

$\mathcal{L}(f)$ has units of dBc/Hz

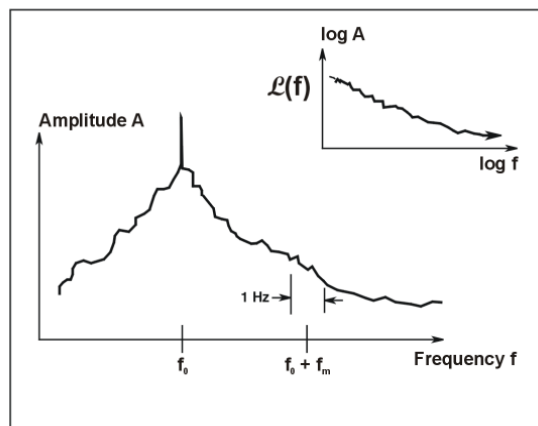

$$\mathcal{L}(f) = 10 \log \left(\frac{\text{Power 1 Hz Bandwidth}}{\text{Total Power in Full BW}} \right)$$

When measuring phase noise directly with an RF spectrum analyzer, the $\mathcal{L}(f)$ ratio is the noise power in a 1 Hz bandwidth, offset from the carrier at the desired offset frequency, relative to the carrier signal power (Figure 6-3).

Figure 6-3 $\mathcal{L}(f)$ Ratio

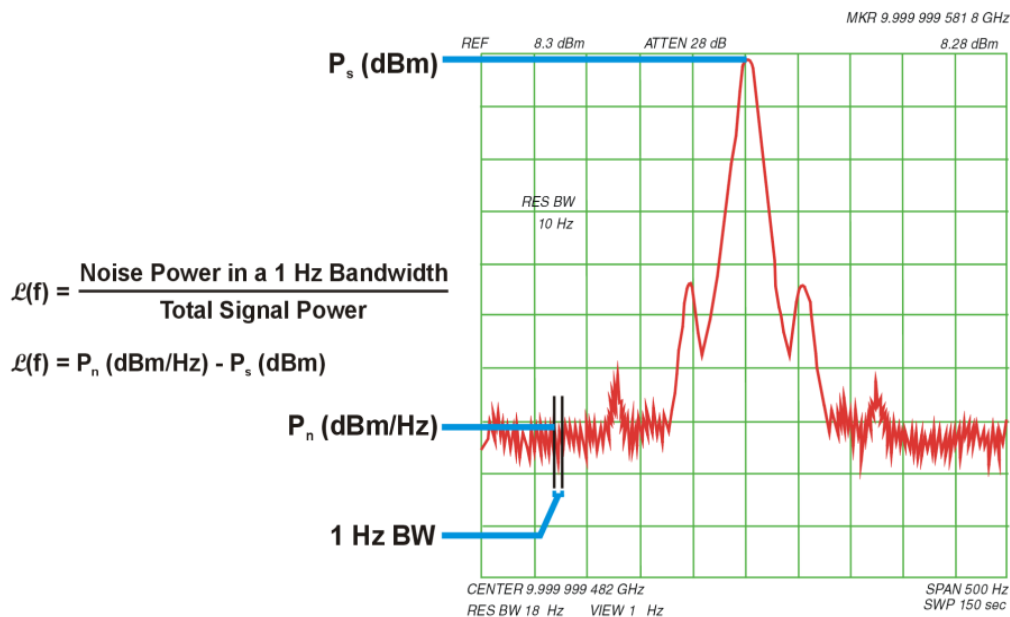

Thermal Noise

Thermal noise (kT) is the mean available noise power from a resistor at a temperature (T) in degrees Kelvin (K). Ambient temperature is assumed to be 290K. As the temperature of the resistor increases, the kinetic energy of its electrons increases and more power becomes available. Thermal noise is broadband and virtually flat with frequency (Figure 6-4).

Figure 6-4

Thermal Noise Power (N_p)

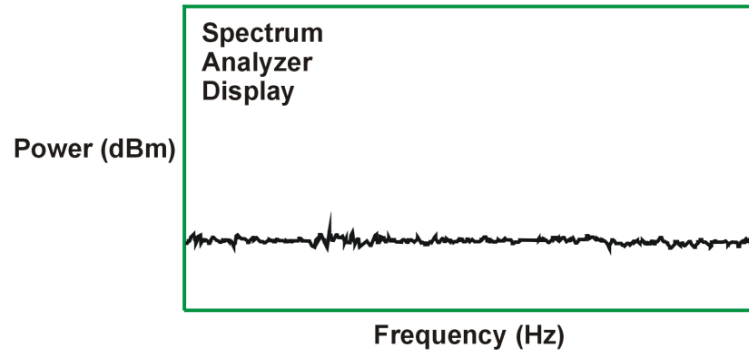

$$N_p = kTB$$

$$\text{For } T = 290 \text{ K, } N_p = -204 \frac{\text{dB (Watts)}}{\text{Hz}} = -174 \frac{\text{dBm}}{\text{Hz}}$$

Thermal noise can limit the extent to which you can measure phase noise. The bandwidth, term B above, is equal to 1 for 1 Hz. Thermal noise as described by kT at room temperature is -174 dBm/Hz . Since phase noise and AM noise contribute equally to kT , the phase noise power portion of kT is equal to -177 dBm/Hz (3 dB less than the total kT power).

If the power in the carrier signal becomes a small value, for example -20 dBm , the limit to which you can measure phase noise power is the difference between the carrier signal power and the phase noise portion of kTB ($-177 \text{ dBm/Hz} - (-20 \text{ dBm}) = -157 \text{ dBc/Hz}$). Higher signal powers allow phase noise to be measured to a lower dBc/Hz level (Figure 6-5).

Figure 6-5 Thermal Noise Effects on Phase Noise Measurements (1 Hz BW)

$$\mathcal{L}(f) = P_n \text{ (dBm/Hz)} - P_s \text{ (dBm)}$$

- Total Power (kTB) = P_n (kTB)
= -174 dBm/Hz
- Phase Noise and AM Noise contribute equally
- Phase Noise Power (kTB)
= -177 dBm/Hz

Theoretical kTB Limits to Phase Noise Measurements for Low Signal Levels

P_s [dBm]	$\mathcal{L}(f)$ [dBc/Hz]
+10	-187
0	-177
-10	-167
-20	-157

Note: There are other measurement factors besides kTB limitations that can reduce the theoretical measurement limit significantly

Other Noise Contributions

In addition to a thermal noise floor that has a relatively constant level with frequency, active devices exhibit a noise flicker characteristic that intercepts the thermal noise at an empirically determined corner frequency (f_c). For offsets below f_c , phase noise increases with f^{-1} . This noise is caused by defects within semiconductor lattice structures resulting in combination-recombination of charge carriers (Figure 6-6). Flicker noise power is approximately -120 dBc/Hz @ 1 Hz offset.

Figure 6-6 Flicker Noise

$$\mathcal{L}(f) = \frac{FkT}{2P_s}$$

Where:
 F = Noise Factor
 k = 198.6 K/Hz
 T = Temp (Kelvin)

f_c = Corner Frequency
 Phase Noise "flicker" appears at frequencies $f < f_c$

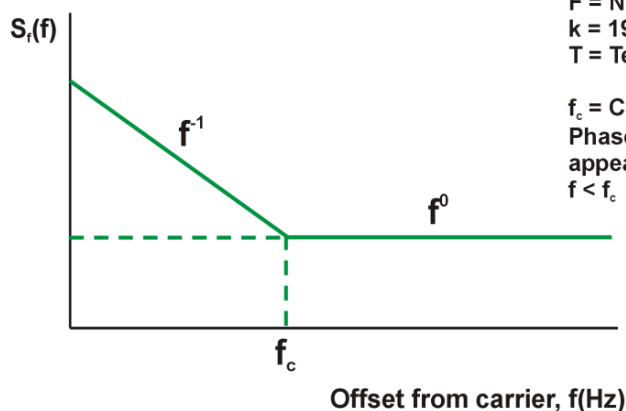

The distribution of other sources of phase noise energy can be described in the terms given in [Figure 6-7](#). Each of these characteristic noise distributions is due to a distinct process in the source circuitry.

Figure 6-7 Typical Phase Noise Distribution

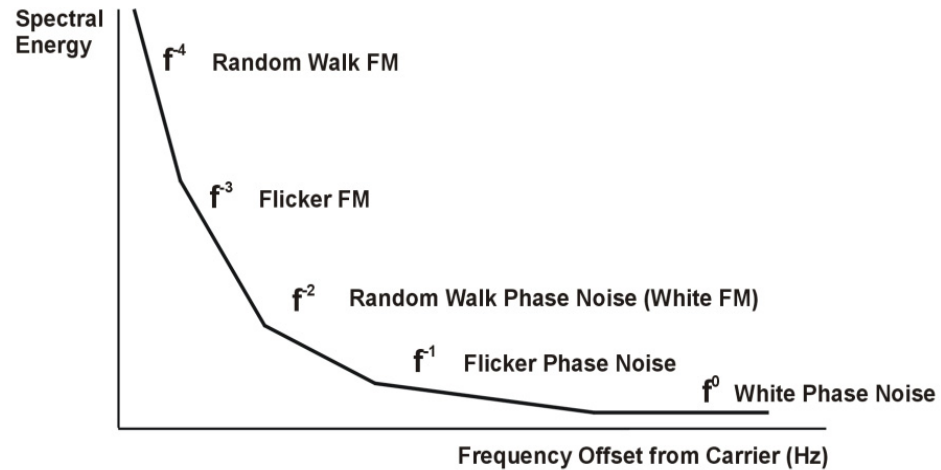

AM Noise

All carriers-with-noise have upper and lower sidebands. These sidebands can alternatively be expressed as “FM” and “AM” sidebands. Most signals measured by phase noise test systems have very little AM sideband power relative to the FM sideband power, so for most signals, measuring the upper (or lower) sideband is equivalent to measuring the FM sideband (phase noise). If the sidebands are due to broadband noise, instead of phase noise, they have equal AM and FM power and the upper sidebands have 3 dB more power than the FM sidebands.

AM noise, described here as $M(f)$, is the power density of amplitude noise in a one hertz bandwidth relative to the carrier power. The example shown here indicates that while AM noise can often be found to be much less than phase noise, there can be offset frequencies at which the AM noise can be equal to or even exceed the value of the phase noise.

The AM Rejection feature in the Phase Noise Measurement Application removes the AM noise contribution from your phase noise measurements for offsets <1 MHz. See [“Advanced Features - AM Rejection and Overdrive”](#) on page 6-159.

Figure 6-8

AM Noise

Single Sideband AM Noise,

$$M(f) = \frac{\text{Spectral Density of one AM Modulation Sideband}}{\text{Total Sideband Power}}$$

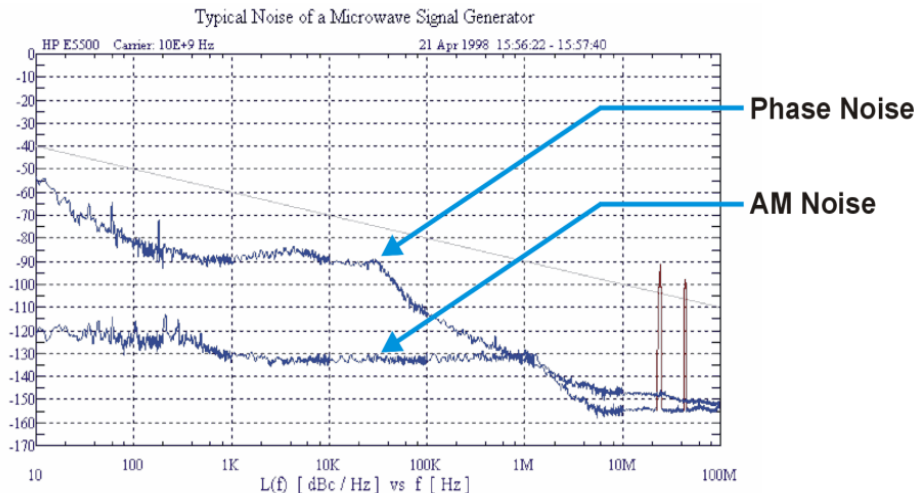

Residual FM

Residual FM is a familiar measure of frequency instability commonly used to specify noise inside a data communications bandwidth. Residual FM is the total rms frequency deviation in a specified bandwidth. Commonly used bandwidths have been 50 Hz to 3 kHz, 300 Hz to 3 kHz, and 20 Hz to 15 kHz. Only the short-term frequency instability occurring at rates within the bandwidth is included. No information regarding the relative weighting of instability is conveyed. Therefore, the energy distribution within the bandwidth is lost.

Since spurious signals are detected as FM sidebands, the presence of large spurious signals near the signal under test can greatly increase the measured level of residual FM. You can use the Monitor Spectrum measurement to determine whether these interfering signals are present.

Single-Sideband Noise

$\mathcal{L}(f)$ is an indirect measure of noise energy easily related to the RF power spectrum observed on a spectrum analyzer. The historical definition is the ratio of the power in one phase modulation sideband per hertz, to the total signal power. $\mathcal{L}(f)$ is usually presented logarithmically as a plot of phase modulation sidebands in the frequency domain, expressed in dB relative to the carrier power per hertz of bandwidth [dBc/Hz].

This historical definition is confusing when the bandwidth of the phase variations are well below 1 Hz because it is possible to have phase noise density values that are greater than 0 dBc/Hz even though the power in the modulation sideband is not greater than the carrier power.

Figure 6-9 Single-Sideband Phase Noise Definition

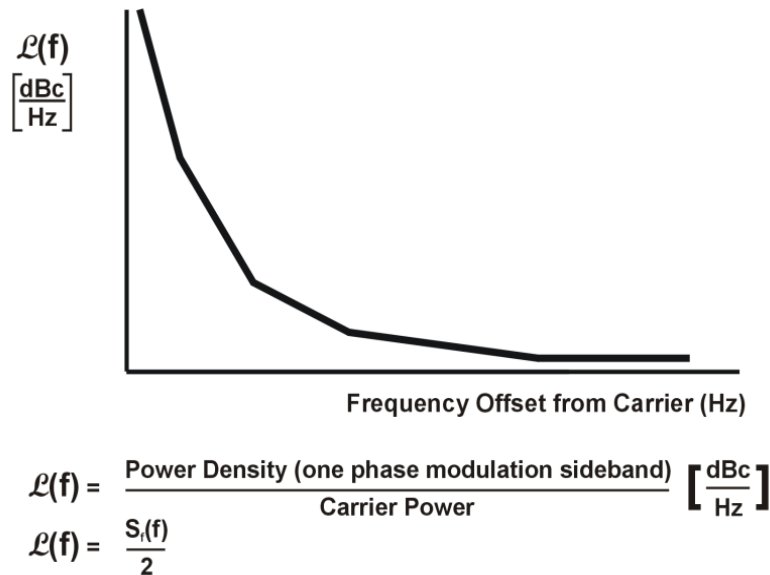

Measurements of $\mathcal{L}(f)$ with a spectrum analyzer typically measure phase noise when the phase variation is much less than 1 radian. Phase noise measurement systems, however, measure $S_f(f)$, which allows the phase variation to exceed this small angle restriction. On this graph, the typical limit for the small angle criterion is a line drawn with a slope of -10 dB/decade that passes through a 1 Hz offset at -30 dBc/Hz. This represents a peak phase deviation of approximately 0.2 radians integrated over any one decade of offset frequency.

The plot of $\mathcal{L}(f)$ resulting from the phase noise of a free-running VCO illustrates the confusing display of measured results that can occur if the instantaneous phase modulation exceeds a small angle (Figure 6-10). Measured data, $S_f(f)/2$ (dB), is correct, but historical $\mathcal{L}(f)$ is obviously not an appropriate data representation as it reaches +15 dBc/Hz at a 10 Hz offset (15 dB more power at a 10 Hz offset than the total power in the signal). The new definition of $\mathcal{L}(f) = S_f(f)/2$ allows this condition, since $S_f(f)$ in dB is relative to 1 radian. Results >0 dB simply mean that the phase variations being measured are >1 radian.

Figure 6-10 Single-Sideband Phase Noise $L(f)$

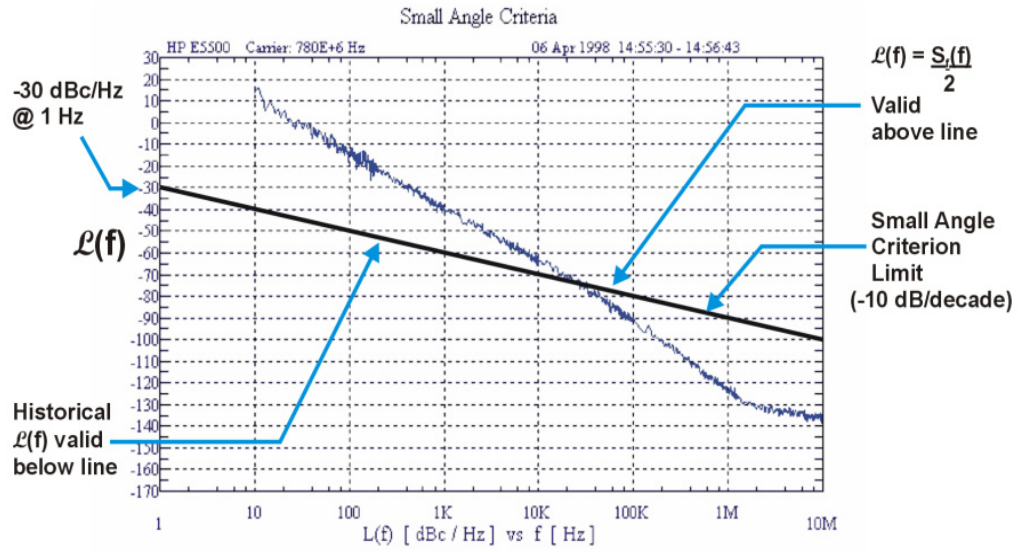

Phase Noise Measurements

Log Plot Measurements

The Log Plot measurement gives a display of dBc/Hz versus logarithmic frequency offset for the single sideband measurement.

Phase noise measurement results can be integrated over a selected frequency range to get the total RMS (root mean squared) noise in a given bandwidth.

RMS Residual FM over a specified range can also be displayed using markers.

RMS phase noise measurements are based on the Log Plot data which is a single-sideband measurement. The RMS phase noise results are mathematically corrected to properly represent the true RMS phase deviation.

Spot Frequency Measurements

A Spot Frequency measurement is a single sideband measurement of the phase error at a specified offset frequency from the main carrier signal.

The analyzer can be set up to track a drifting signal by pressing using signal tracking. When signal tracking is on, a graph with a trace showing the change in frequency versus time is shown next to the Spot Frequency plot.

Improving Phase Noise Measurements

Smoothing, Averaging and Filtering

Repeatability of a measured trace can be improved in several different ways. Smoothing is used with Log Plot measurements while trace averaging is used with Spot Frequency measurements. Video filtering can be used with both types of measurements.

The smoothing process averages a number of adjacent trace points from the raw trace and displays the smoothed result in a second trace for a log plot measurement. Smoothing is faster than averaging or filtering, but less accurate than either. Loss of accuracy is particularly noticeable when a trace has sudden changes in amplitude, for example when a carrier has a large discrete signal such as a spurious sideband.

Video filtering can be applied to the active trace when making measurements. Additional video filtering improves the repeatability of the measurement but makes the measurement process slower.

The averaging process (trace averaging) measures each point on multiple independent sweeps and converges on the average at each point. Trace averaging and video filtering require about the same amount of additional time to reach the same level of repeatability. The biggest difference is that with video filtering, the trace is smooth as it is being created, while with trace averaging, intermediate less smooth results are visible.

The averaging process measures each frequency point multiple times, and then calculates and plots the average value.

Signal Tracking

Signal tracking can be used in all measurements to track a slowly drifting signal. When it is enabled (**On**), the measurement will follow a slowly drifting signal by reacquiring the carrier signal at the beginning of each trace.

If the signal is not tracked correctly (such as might happen with a rapidly drifting signal), the analyzer may not completely compensate for the drift, with the off-frequency measurement causing the phase noise to appear either higher or lower than it actually is.

Slowly Drifting Signals

Spot Frequency and Log Plot measurements can be made on slowly drifting signals by making use of the signal tracking function, although the measured value may be slightly less accurate.

System Noise Floor

The system noise floor can have a significant effect on low phase noise measurements such as those that will typically be found at large frequency offsets. The system noise floor can be measured using one of two methods. See [Creating a DANL Floor Reference Trace](#) for a procedure on measuring the DANL Floor. See [Example Measurement - Using a DANL Reference for Cancellation](#) for a procedure on using the trace to improve accuracy.

Advanced Features - AM Rejection and Overdrive

AM Rejection

AM Rejection is ON by default for Phase Noise measurements for offsets <1 MHz. Therefore, if a measurement shows a step change in phase noise at 1 MHz offset, you can either change the offset or turn AM rejection OFF to determine whether AM Noise is the reason for the observed step change.

Overdrive

If you are measuring offsets > 1 MHz you can use the Overdrive feature to increase the dynamic range of the instrument. Overdrive uses the electronic step attenuator, if available, or the mechanical step attenuator to optimize input signal levels. The measurement is slowed by the respective attenuator switching time. Although measurement accuracy may improve with increased dynamic range, the measurement uncertainty increases slightly with attenuator switching.

Overdrive has the advantage of allowing higher dynamic range at the extreme offsets where broadband input noise of the analyzer might otherwise dominate over the analyzer's phase noise in setting the available dynamic range. Overdrive has the disadvantage of requiring attenuation changes between measuring the carrier power and measuring the noise density offset from that carrier. The accuracy of the phase noise measurement is the accuracy of the ratio of these two. Therefore, phase noise amplitude accuracy is degraded (by the attenuator switching uncertainty) at those offsets where overdrive occurs when it is allowed. Also, switching the attenuator slows the measurement.

Additional Information

The documents listed below provide more information on making phase noise measurements. They can be obtained through your local Agilent sales representative.

Agilent Part Number	Title
5952-0292	AN 150 Spectrum Analyzer Basics
5968-2081E	AN 1309 Pulsed Carrier Phase Noise Measurements
5989-5718EN	Using Clock Jitter Analysis to Reduce BER in Serial Data Applications
5988-6082EN	AN 1397-1 Lowering Cost & Improving Interoperability by Predicting Residual BER:
5954-6365	AN 343-1 Vector Modulation Measurements
5952-8203	AN 283-1 Applications and Measurements of Low Phase Noise Signals Using 8662A

7

If You Have A Problem

Agilent Customer Assistance

By internet, phone, or fax, get assistance with all your test and measurement needs.

Online assistance: <http://www.agilent.com/find/assist>

United States

(tel) 1 800 829 4444
(fax) 1 800 829 4433

Latin America

(tel) (305) 269 7500
(fax) (305) 269 7599

Canada

(tel) 1 877 894 4414
(fax) (905) 282-6495

Europe

(tel) (+31) 20 547 2323
(fax) (+31) 20 547 2390

New Zealand

(tel) 0 800 738 378
(fax) 64 4 495 8950

Japan

(tel) (81) 426 56 7832
(fax) (81) 426 56 7840

Australia

(tel) 1 800 629 485
(fax) (61 3) 9210 5947

Asia Pacific

(tel) (852) 3197 7777
(fax) (852) 2506 9284

A

- active license key, 20
 - how to locate, 20
- advanced functions
 - Meas Setup, 86
- Agilent Technologies URL, 2
- Amplitude menu map, 41, 42, 43
- AMPLITUDE Scale
 - Ref Level, 75
- AMPLITUDE Y Scale
 - Delta Freq, 76
 - front-panel key, 75
 - Phase Noise, 76
 - Ref Position, 75
- AMPLITUDE Y Scale menu, 41, 42, 43
- amplitude Y scale/div
 - monitor measurement, 75
- Annotation
 - Display, 79
- applications
 - currently available, 108
 - applications, selecting, 108, 109
- ASCII data format, 106
- attenuation, 127
- attenuator, 75
- average
 - counts, 141
 - spot frequency, 141
- average count
 - log plot, 130, 131
- average mode, 85
- Averages
 - viewing, 79
- averaging, 26, 158
 - log plot, 131
 - monitor band/channel, 137, 138
 - spot frequency, 142
- Avg Mode key, 85
- Avg Number
 - Meas Setup, 85

B

- bandwidth
 - resolution BW, 142
 - setting resolution BW, 131, 132, 142
 - setting video BW, 132, 142
 - span ratio, 135, 136
 - video BW, 143
 - video BW ratio, 132, 143
- begin measurement, 107
- blank trace, 95
- both
 - tracking mode, 81

C

- cancellation
 - Meas Setup, 87
 - reference trace, 87
 - threshold, 87
- cancellation on log plot
 - measurements, 29
- Carrier Freq key, 80
- Carrier Search, 80
- carrier search
 - search span, 80
- carrier signal
 - tracking drift, 124, 125, 126
- carrier signal frequency, 123
- carrier signal search, 123
- carrier signal search span, 124, 126, 128, 129, 130
- changing
 - instrument settings, 122
- Channel menu map, 54
- characteristics, 14
- Choose Option key, 19
- commands
 - CONFigure, 112
 - FETCh, 113
 - MEASure, 111
 - READ, 114
- compatibility, 14
- CONFigure command use, 111
- CONFigure commands, 112
- continuous measurement, 94
- continuous sweep, 94
- copy trace
 - log plot, 98
- current measurement, 102

D

- DANL, 122
 - measuring, 82
 - spot frequency, 143
- DANL cancellation, 133
 - delta, 133
- DANL floor
 - log plot, 29
- DANL floor noise measurement, 86
- DANL floor reference
 - example measurement, 31
- DANL measurement, 136
- DANL method, 82
 - attenuation, 82
 - removal, 82
- DANL noise
 - measuring, 82
- data format, 106
- data from measurements, 111
- decade table, 98

- Meas Setup, 87
- default settings
 - restoring, 85, 91
- default values, setting remotely, 112
- defaults, 122
- deleting an
 - application/personality, 15
- delta, 83
 - marker, 99
- Delta Freq
 - AMPLITUDE Y Scale, 76
 - Ref Value, 76
 - Scale/Div, 76
- demodulation functions, 78
- Det/Demod
 - front-panel key, 78
- detection mode, 134, 143
- detection type, 134, 143
- disk drive commands, 119
- Display, 77, 79
 - Annotation, 79
 - front-panel key, 77, 79
 - Full Screen, 79
 - Graticule, 79
 - menu, 77, 79
 - Preferences, 79
 - Tolerance Limits, 79
 - View Avg, 79
- display
 - amplitude scale, 104
 - display line, 103
 - display ref level, 103
- display average noise level, 122
- display commands, 103
- Display Line
 - monitor measurements, 79
- Display menu map, 44, 45, 46, 47
- drift span, 80
- drifting signals, 28, 124, 125, 126, 158
 - tracking, 80, 81

E

- equipment required, 14
- example measurement
 - DANL floor reference, 31
 - noise cancellation, 31, 34
 - signal phase noise reference, 34

F

- Factory Preset key, 92
- FETCh command use, 111
- FETCh commands, 113
- file menu, 48
- files
 - traces, 119, 120

- Filtering
 - Little, 87
 - Maximum, 87
 - Medium, 87
 - None, 87
- filtering, 26, 158
 - log plot, 134
 - Meas Setup, 86
- format, data, 106
- frequency
 - carrier search, 123
 - carrier search span, 124, 126, 128, 129, 130
 - carrier signal, 123
 - span, 138, 139
 - start offset, 135
 - stop offset, 135
- FREQUENCY Channel
 - front-panel key, 80
- FREQUENCY Channel menu
 - map, 54
- frequency error, 84
- frequency span
 - full, 139
 - setting, 138
 - zero, 139
- front-panel key
 - AMPLITUDE Y Scale, 75
 - Det/Demod, 78
 - Display, 77, 79
 - FREQUENCY Channel, 80
 - Input, 82
 - Input/Output, 82
 - Marker, 83
 - Meas Setup, 85
 - MEASURE, 89
 - MODE, 90
 - Mode Setup, 91
 - Preset, 92
 - SPAN X Scale, 93
 - Sweep Menu, 94
 - Trace/View
 - View/Trace. See front panel key
 - Trace/View
- Full Screen
 - Display, 79
- full span
 - monitor measurements, 93
- G**
- graphical view, 96
- Graticule
 - Display, 79
- GSM Mode defaults, 122
- I**
- initiate measurement, 107
- Input, 82
 - max mixer level, 82
- input attenuation, 127
 - monitor measurement, 75
- Input front-panel key, 82
- input level, 82
- Input/Output
 - Advanced, 82
 - Corrections, 82
 - Max Mixer Level, 82
 - max mixer level, 82
- input/output, 82
- Input/Output front-panel key, 82
- Install Now key, 19
- Installer menu map, 55
- Installing and Obtaining a license key, 19
- installing measurement
 - personalities, 15
- instrument configuration, 108
- interval
 - tracking mode, 80, 81
- J**
- jitter
 - noise, 84
- L**
- license key
 - obtaining and installing, 19
- Little
 - Filtering, 87
- load/save, 96
- loading
 - traces from file, 119
- loading an
 - application/personality, 15
- loading files, 96
- loading trace data, 96
- log plot, 89, 98
 - average count, 130, 131
 - copy trace, 98
 - DANL floor, 29
 - filtering, 134
 - method, 136
 - phase noise, 130
 - resolution bandwidth, 131, 132
 - smooth trace, 137
 - span/rbw ratio, 135, 136
 - start offset, 135
 - stop offset, 135
 - swap traces, 99
 - trace mode, 98
 - video bandwidth, 132
 - video/rbw ratio, 132
- log plot - averaging mode, 131
- log plot measurement, 115, 130
- log plot measurements, 25, 157
- log plot noise cancellation, 30
- M**
- making measurements, 111
- man, 128
- Marker, 83
 - All Off, 84
- marker, 99, 100, 101
 - delta, 83
 - normal, 83
 - off, 84
 - Residual FM, 84
 - RMS noise, 83
 - RMS noise degrees, 83
 - RMS noise jitter, 84
 - RMS noise radians, 84
 - select marker, 83
 - table, 84
 - trace, 84
 - trace number, 100
 - X axis position, 100
 - Y axis position, 101
- Marker front-panel key, 83
- marker table, 100
- markers, 99
- mass storage commands, 119
- Max Mixer Level, 82
- max mixer level
 - input, 82
 - input/output, 82
- Maximum
 - Filtering, 87
- maximum power to mixer, 140
- Meas, 85
- Meas Setup
 - advanced functions, 86
 - Avg Number, 85
 - cancellation, 87
 - decade table, 87
 - filtering, 86
 - Meas Type, 85
 - Monitor Spectrum, 58, 59, 60
 - PhNoise Opt f, 86
 - RBW/spot offset, 86
 - reference trace, 87
 - Restore Meas Defaults, 85
 - smoothing, 86
 - spot offset, 86
 - table index, 86
 - threshold, 87
- Meas Setup front-panel key, 85
- Meas Type
 - Meas Setup, 85
- meas type
 - DANL floor, 86
 - phase noise, 85

- measure, 89
 - MEASure command use, 111
 - MEASure commands, 111
 - MEASURE front-panel key, 89
 - MEASURE menu map, 56, 57
 - measurement, 89
 - initiate, 107
 - log plot, 130
 - query current, 102
 - spot frequency, 141
 - measurement format, 106
 - measurement modes
 - currently available, 108
 - selecting, 108, 109
 - measurements
 - CONF/FETC/MEAS/READ
 - commands, 111
 - getting results, 111
 - log plot, 115
 - monitor band/channel, 117, 137
 - setting default values remotely, 112
 - spot frequency, 118
 - Medium
 - Filtering, 87
 - memory commands, 119
 - menu map
 - Amplitude, 41, 42, 43
 - Channel, 54
 - Display, 44, 45, 46, 47
 - FREQUENCY Channel, 54
 - Installer, 55
 - MEASURE, 56, 57
 - Mode Setup, 62
 - Monitor Spectrum, 58, 59, 60
 - Noise Cal, 61
 - SPAN X Scale, 63, 64, 65
 - Sweep, 66, 67
 - Trace, 69, 70, 71
 - Trig, 68
 - View/Trace, 69, 70, 71
 - method
 - log plot, 136
 - spot frequency, 143
 - min carrier lvl, 82
 - minimum carrier level, 82
 - minimum input level, 82
 - missing options, 15
 - mixer
 - maximum input power, 140
 - mixer level
 - maximum, 82
 - mode
 - phase noise, 90
 - MODE front-panel key, 90
 - Mode Preset key, 92
 - Mode Setup
 - Restore Mode Setup Defaults, 91
 - mode setup
 - properties, 91
 - Mode Setup front-panel key, 91
 - Mode Setup menu map, 62
 - monitor
 - sweep time, 140
 - trace points, 139
 - monitor band/channel - average count, 137
 - monitor band/channel - averaging state, 138
 - monitor band/channel - averaging termination control, 138
 - monitor band/channel measurement, 117, 137
 - monitor band/channel
 - See also MON
 - Monitor Spectrum, 89
 - Meas Setup, 58, 59, 60
 - menu map, 58, 59, 60
 - moving data between traces, 95
- N**
- noise
 - measuring, 82
 - Noise Cal menu map, 61
 - Noise cancellation
 - example measurement, 30, 31, 34
 - noise cancellation, 133
 - delta, 133
 - example measurement, 31, 34
 - log plot, 30
 - noise floor
 - checking, 28, 159
 - noise jitter, 84
 - None
 - Filtering, 87
 - normal, 83
 - numerical view, 96
- O**
- offset
 - spot frequency, 145
 - offset start
 - log plot, 135
 - offset stop
 - log plot, 135
 - operations on traces, 95
 - optimization
 - spot frequency, 144
 - optimized ref level, 126
 - optimizing reference level
 - monitor measurement, 75
 - options
 - loading/deleting, 15
 - options not in instrument memory, 15
- P**
- performance specifications, 14
 - personalities
 - currently available, 108
 - selecting, 108, 109
 - personality options not in instrument, 15
 - Phase Noise
 - AMPLITUDE Y Scale, 76
 - Ref Value, 76
 - phase noise
 - degrees, 99
 - frequency, 99
 - jitter, 99
 - log plot, 130
 - radians, 99
 - spot frequency, 141
 - phase noise cancellation, 87
 - phase noise measurement, 85, 115, 118
 - phase noise measurement information, 160
 - phase noise mode, 90
 - PhNoise Opt f
 - Meas Setup, 86
 - position
 - marker, 99, 100, 101
 - Preferences
 - Display, 79
 - preset
 - factory, 92
 - mode, 92
 - user, 92
 - Preset front-panel key, 92
 - properties
 - mode setup, 91
- R**
- raw trace, 95
 - RBW, 145
 - RBW/spot offset
 - Meas Setup, 86
 - READ command use, 111
 - READ commands, 114
 - real number data format, 106
 - Ref Level
 - AMPLITUDE Scale, 75
 - log plot measurement, 75
 - Ref Position
 - AMPLITUDE Y Scale, 75
 - Ref Value
 - Delta Freq, 76
 - Phase Noise, 76

- Ref Value key
 - remote command, 134
 - Reference (View) trace, 95
 - reference level
 - log plot measurement, 134
 - reference trace
 - cancellation, 87
 - DANL floor, 31
 - Meas Setup, 87
 - signal phase noise, 34
 - Res BW
 - BW/Avg, 77
 - res BW mode
 - auto, 128
 - Residual FM, 84
 - Resolution Bandwidth, 145
 - resolution bandwidth
 - log plot, 131, 132
 - on/off, 142
 - setting, 131, 132, 142
 - spot frequency, 142
 - resolution bandwidth query, 127
 - Restore Meas Defaults
 - Meas Setup, 85
 - Restore Mode Setup Defaults
 - Mode Setup, 91
 - results format, 106
 - RMS noise, 83
 - RMS noise degrees, 83
 - RMS noise jitter, 84
 - RMS noise radians, 84
 - RMS phase noise, 25, 157
- S**
- sample measurement
 - DANL floor reference, 31
 - noise cancellation, 31, 34
 - signal phase noise reference, 34
 - saving files, 48, 96
 - saving trace data, 96
 - Scale/Div
 - Delta Freq, 76
 - log plot measurement, 75
 - search
 - carrier signal, 123
 - Search Span, 80
 - search span
 - carrier signal, 124, 126, 128, 129, 130
 - See “Log Plot Video Bandwidth”
 - on page 658., 134
 - select marker, 83
 - SENSE defaults, 122
 - setting
 - Avg Mode, 85
 - carrier frequency, 80
 - carrier search, 80
 - signal phase noise reference
 - example measurement, 34
 - Signal tracking, 80
 - Signal tracking mode, 81
 - both, 81
 - interval, 80, 81
 - tolerance, 81
 - single frequency measurements, 26, 157
 - single measurement, 94
 - single sweep, 94
 - smooth trace
 - log plot, 137
 - smoothed trace, 95
 - smoothing, 26, 158
 - Meas Setup, 86
 - span
 - carrier signal search, 124, 126, 128, 129, 130
 - monitor measurements, 93
 - Span key, 93
 - ref value, 93
 - scale/div, 93
 - start offset, 93
 - stop offset, 93
 - span setting, 138, 139
 - SPAN X Scale front-panel key, 93
 - SPAN X Scale menu map, 63, 64, 65
 - Span/RBW
 - BW/Avg, 77
 - span/resolution bandwidth ratio, 135, 136
 - log plot, 135, 136
 - specifications, 14
 - spectrum, monitor, 89
 - spot frequency, 89
 - average, 141
 - average number of counts, 141
 - DANL, 143
 - method, 143
 - offset, 145
 - optimization, 144
 - phase noise, 141
 - resolution bandwidth, 142
 - sweep time, 145, 146
 - video bandwidth, 142, 143
 - video/rbw ratio, 143
 - spot frequency - averaging mode, 142
 - spot frequency measurement, 118, 141
 - spot frequency measurements, 26, 157
 - spot offset
 - Meas Setup, 86
 - start measurement, 107
 - start offset
 - log plot, 135
 - state
 - changing, 122
 - stop offset
 - log plot, 135
 - storing
 - traces to file, 120
 - swap traces
 - log plot, 99
 - sweep, 94
 - auto sweep time, 94
 - continuous, 94
 - FFT & sweep, 94
 - single, 94
 - Sweep Menu front-panel key, 94
 - Sweep menu map, 66, 67
 - sweep time, 94
 - monitor, 140
 - spot frequency, 145, 146
 - system noise floor, 28, 159
- T**
- table
 - marker, 84
 - table index
 - Meas Setup, 86
 - threshold
 - cancellation, 87
 - Meas Setup, 87
 - tolerance
 - tracking drift, 81
 - tracking mode, 81
 - Tolerance Limits
 - Display, 79
 - trace, 84, 95
 - blank, 95
 - marker number, 100
 - Reference (View), 95
 - trace format, 106
 - trace mode
 - log plot, 98
 - trace points
 - monitor, sweep
 - trace points, 139
 - Trace/View front-panel key
 - traces
 - loading from file, 119
 - moving data between, 95
 - storing to file, 120
 - tracking, 124
 - drift span, 124
 - tracking a drifting signal, 124, 125, 126
 - tracking interval, 125
 - tracking mode, 125
 - both, 81

interval, [80](#), [81](#)
tolerance, [81](#)
tracking signals, [80](#), [81](#)
 drift span, [80](#)
 tolerance, [81](#)
tracking tolerance, [126](#)
trigger measurement, [107](#)

U

Uninstall Now, [20](#)
uninstalling measurement
 personalities, [15](#)
URL (Agilent Technologies), [2](#)
User Preset key, [92](#)
using cancellation with log plog
 measurements, [29](#)
using the utility, [25](#), [157](#)

V

VBW, [128](#)
VBW/RBW
 BW/Avg, [77](#)
video bandwidth
 log plot, [132](#)
 on/off, [143](#)
 setting, [132](#), [142](#)
 spot frequency, [142](#), [143](#)
video bandwidth mode, [128](#)
Video BW
 BW/Avg, [77](#)
video/resolution bandwidth ratio,
 [132](#), [143](#)
 log plot, [132](#)
 spot frequency, [143](#)
View averages, [79](#)
View Avg
 Display, [79](#)
view commands, [103](#)
View/Trace
 blank trace, [95](#)
 graphical view, [96](#)
 load/save, [96](#)
 numerical view, [96](#)
 operations, [95](#)
 raw trace, [95](#)
 Reference (View) trace, [95](#)
 smoothed trace, [95](#)
 trace, [95](#)
View/Trace front-panel key. See
 Trace/View front-panel key
View/Trace menu map, [69](#), [70](#), [71](#)

X

X axis position
 marker, [100](#)

Y

Y axis position
 marker, [101](#)

Z

zero span, [139](#)
 monitor measurements, [93](#)

